

**culina**  
LEISURE

UBGHJ608

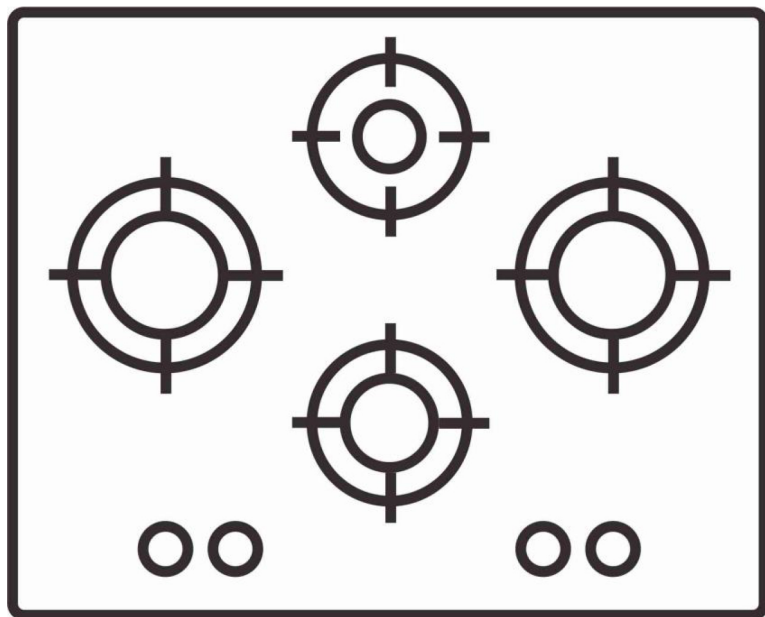

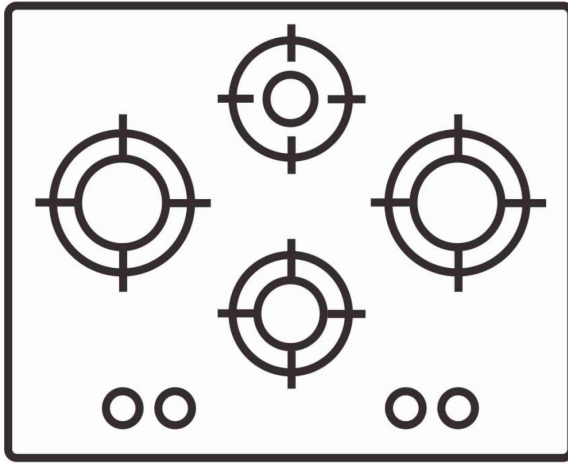

[01] x 1

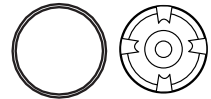

[02] x 2



[03] x 1



[04] x 1

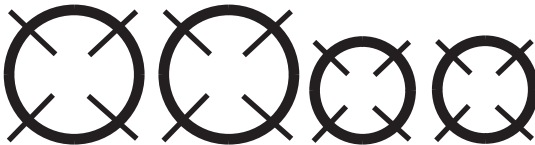

[05] x 1 set



[06] x 1

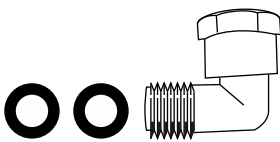

[11] x 1set



[07] x 4

1 : 1



[08] x 4



[09] x 4



[10] x 1

# UBGHJ608





Built-in Gas Hob

Installation

24

# Let's get started...

	<b>Getting started...</b>	<b>05</b>
	<b>Before you start</b>	06
	<b>Safety</b>	07
	<b>In more detail...</b>	<b>09</b>
	<b>Product functions</b>	10
	<b>Operation</b>	11
	<b>Care and maintenance</b>	13
	<b>Troubleshooting</b>	15
	<b>Recycling and disposal</b>	15
	<b>Technical and legal information</b>	16
	<b>Appendix</b>	
	<b>Installation</b>	



# Getting Started...

**Before you start  
Safety**

06

07

## Before you start

- To avoid the risks that are always present when you use an electrical appliance it is important that this appliance is installed correctly and that you read the safety instructions carefully to avoid misuse and hazards. please keep this instruction booklet for future reference and pass it on to any future owners. after unpacking the appliance please check that it is not damaged. If in doubt, do not use the appliance but contact Customer Services on 0344 800 1128 (UK), 014475261 (Ireland)
- Check the package and make sure you have all of the parts listed.
- Decide on the appropriate location for your product.
- If this product contains glass please take care when fitting or handling to prevent personal injury or damage to the product.
- The specifications plate is available on this appliance. This plate displays all the necessary identification information for ordering replacement parts.
- If you sell the appliance, give it away, or leave it behind when you move house, make sure you also pass on this manual so that the new owner can become familiar with the appliance and its safety warnings.

## Tools required

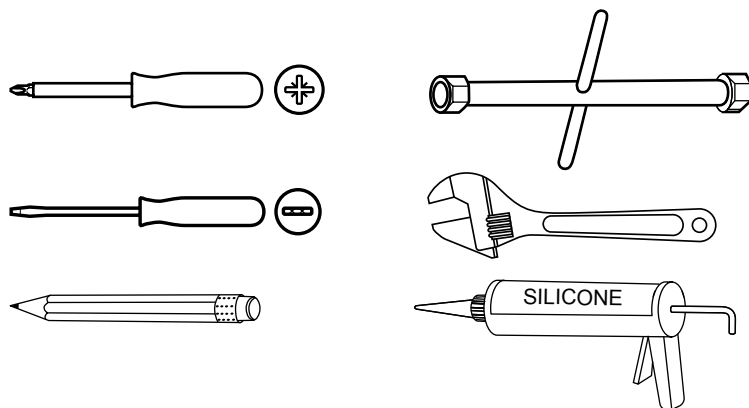

**These instructions are for your safety. Please read through them thoroughly prior to installation and retain them for future reference.**



- All installation work must be carried out by a qualified Gas Safe registered engineer.
- This appliance must be installed correctly by a suitably qualified person, strictly following the manufacturer's instructions.

- This appliance complies with all current European safety legislation, however, the Manufacturer must emphasise that this compliance does not prevent the surfaces of the appliance from heating up during use and remaining hot during its operation.
- Accessible parts may become hot during use. Young children should be kept away. Care should be taken to avoid touching the appliance (e.g hob, cooker).
- The Manufacturer highly recommends that this appliance be kept out of the reach of babies and small children.
- Children should be supervised to ensure that they do not play with the appliance.
- This appliance is not intended for use by persons (including children) with reduced physical sensory, or mental capabilities, or by those who lack experience and knowledge, unless they have been given supervision and instruction concerning the use of the appliance by a person responsible for their safety.
- Means for isolating the appliance must be incorporated in the fixed wiring in accordance with the current wiring regulations. An all-pole disconnection switch having a contact separation of at least 3 mm in all poles should be connected in fixed wiring.

- Damaged power cables should be replaced by a competent person or qualified electrician
- Make sure that the power cord is not caught under or in the appliance and avoid damage to the power cable.
- Do not allow the electric cables to touch the hot parts of the appliance.
- Do not install the appliance outdoors in a damp place or in an area which may be prone to water leaks such as under or near a sink unit. In the event of a water leak allow the machine to dry naturally.
- Please dispose of the packing material carefully.
- Do not use flammable sprays in close vicinity to the appliance
- We also recommend that great care be taken during use and cleaning. Read the cleaning and maintenance sections for this appliance carefully.
- A steam cleaner is not to be used.
- The appliance is not intended to be operated by means of external timer or separated remote-control system.
- The appliance is for domestic use only.
- When a cooking zone has been on for a long time, the surface remains hot for some time afterwards so do not touch the metal surface.
- Do not store detergents or flammable materials beneath the hob
- Do not leave hot oils or fats unattended as they may catch light.
- The Manufacturer declines all liability for personal or material damage as a result of misuse or incorrect installation of this appliance.





## In more detail...

<b>Product functions</b>	10
<b>Operation</b>	11
<b>Care and maintenance</b>	13
<b>Troubleshooting</b>	15
<b>Recycling and disposal</b>	15
<b>Technical and legal information</b>	16

## Product functions

- 4 x Burners: Four zones of cooking.
- Flame safety device (FSD): Stops the gas supply to the gas hob when the flame goes out
- auto - ignition
- LPG conversion kit supplied.

## Control elements

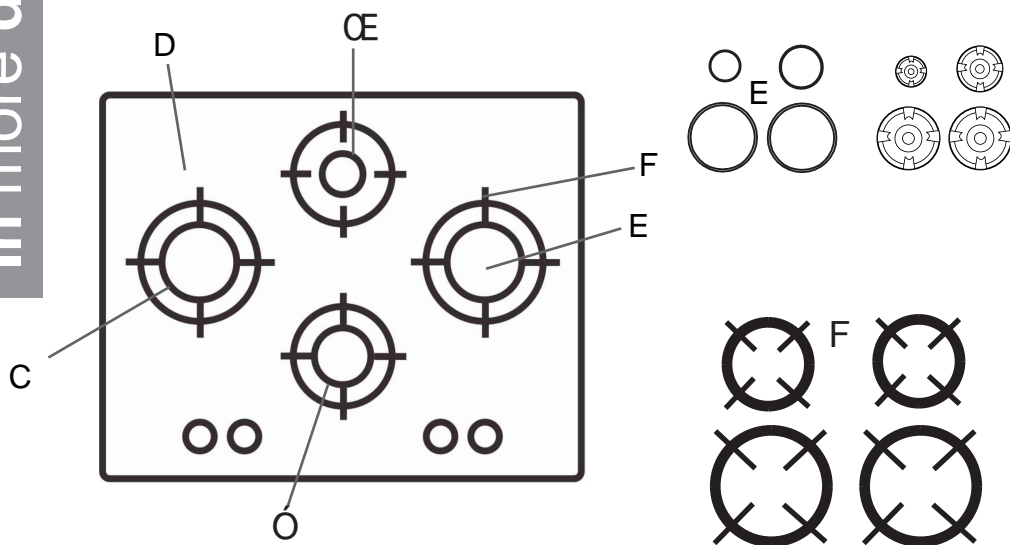

Reference	Description	Qty	Reference	Description	Qty
A	Auxiliary burner	1	D	Panel	1
B	Semi-rapid burner	2	E	Burner Cap	4
C	Flame safety device (FSD)	1	F	Pan Support	4

**Caution:** This diagram may be slightly different from the layout of the appliance.

## Operation



### Use of the burners



#### Caution

- If there is no electric current you can light the burners with piezo electric spark gas ignitor.
- The burners can only be lit with safety thermocouples when the knob is on **MAXIMUM**.

On the control panel (fig.4) to the left of every knob there is a diagram that indicates the burner to which the knob in question refers. The burners can be switched on in several ways, according to the type of appliance and its individual features.

- > Automatic electric “ON” switch for burners with safety device (thermocouples)
  - Turn the knob (fig. 5) corresponding to the selected burner in a counter-clockwise direction so that the knob is at **MAXIMUM**.
  - Once the burner is lit, keep the knob pressed in for about 10 seconds in order to allow the flame to heat up the thermocouple. If the burner goes out when the knob is let go, repeat the operation.

## NOTE:

- > The use of a gas cooking appliance produces heat and humidity in the place where it is installed.
- > Therefore, you need to ensure the place is well ventilated, keeping the natural ventilation openings clear and using a mechanical ventilation device/ flue or electric fan
- > Intensive or prolonged use of the appliance may require additional ventilation, such as opening a nearby window or increased ventilation efficiency obtained by increasing the power of the mechanical ventilators where applicable.

Advice for the best use of the burner:

- > When boiling point is reached, turn the knob to MINIMUM.
- > Always use pans with a lid .

Burner	Minimum Diameter	Maximum Diameter
Large (rapid)	180mm	240mm
Medium (semi-rapid)	140mm	180mm
Small (auxiliary)	120mm	140mm

## WARNING

If you use a saucepan that is smaller than the recommended diameter the flame will spread beyond the bottom of the vessel, causing the handle to overheat.

Never leave empty pot or pans over a lit burner.

Do not use tools for grill cooking on gas on glass hobs.

## Appliance cleanliness



### Warning

Always switch off the electricity supply before performing maintenance work. In the event of a fault, contact customer services.

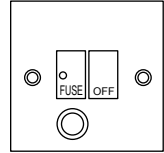

### Caution

- Use soapy water and a cloth for cleaning. Never use abrasive powders.
- Avoid banging pots and pans down on the hob.
- Do not leave any empty pan on the heating zone.

- > The appliance should be cleaned after use.
- > Wipe the inner and outer surface of the appliance and its accessories with wet cloth.
- > Any liquid overflowing from the pan must always be removed with a cloth.
- > The surface of the hob may be easily cleaned as follows

### Cleaning the hob panel.

Regularly wipe over the hob top with a soft cloth well rung out in warm water to which a little washing up liquid has been added. Avoid use of the following:

- 1) Household detergent and bleaches.
- 2) Soap impregnated scouring pads.
- 3) Steel wool.
- 4) Bath/sink stain removers.

### Cleaning the pan supports.

If washing them by hand, take care when drying them as the enameling and dying process occasionally leaves rough edges. If necessary remove stubborn stains using a paste cleaner.

### Cleaning the burners.

The burner caps and crowns can be removed for cleaning. Wash the burner caps and crowns using hot soapy water and remove marks using a mild paste cleaner.

A well moistened soap impregnated steel wool pad can be used with caution if the marks are particularly difficult to remove. After cleaning make sure to dry using a soft cloth.

Note: It is very important to keep the thermocouples and the ignition candles in a clean condition to prevent problems lighting and maintaining a flame on the burners.

## Replacement of parts

---

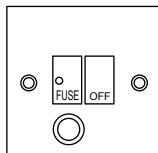

### Warning

Always switch off the electricity supply before performing maintenance work. In the event of a fault, contact customer services.

## Troubleshooting

---

The following circumstances may not be a problem. Do not contact the customer services until the problem has been confirmed.

If your appliance is still not functioning properly after making the above checks, please contact customer services.

1. Check that the mains supply has not been switched off.
2. Check that the fuse in the spur has not blown.
3. Ensure that the burner components are not excessively soiled as this can lead to ignition problems.

Do not take the appliance apart yourself, as you may damage the hob.

Before calling After Sales Service, please do the following:

1. Check that the appliance is correctly connected.
2. Read the failure text above. If you are still unable to solve the problem, switch off the appliance, do not try to take it apart and call customer services.

## Recycling and disposal

---

### Environmental protection

Waste electrical products should not be disposed of with household waste. Please recycle where facilities exist. Check with your Local Authority or retailer for recycling advice.



The symbol on the product or its packaging indicates that this product cannot be treated as normal household waste. This product must be handed over to an electric and electronic equipment collection point for recycling.

On ensuring that this product is disposed of correctly, you will help to avoid possible negative consequences for the environment and public health, which could occur if this product is not handled correctly. To receive more detailed information about recycling this product, contact your local government, domestic waste disposal services or the outlet where the product was bought.

## Technical data

Power Supply	V/Hz	220-240 Vac 50Hz
Gas Pressure	mbar	G20-20mbar G30-28~30/37mbar
External Dimensions	HxDxW mm	110x510x110

	NG (G20 20mbar)		LPG(G30 28~30/37mbar)	
	Injector Dia. (mm) and kW		Injector Dia. (mm) and kW	
Gas Category	Dia	kW	Dia	kW
Rapid Burner	1.14	2.5	0.81	2.5
Semi rapid burner	0.98	1.75	0.69	1.75
Auxiliary burner	0.74	1.0	0.51	1.0

Overall Dimensions:

Width: 510mm Depth: 510mm

Cut-out Dimensions

Width: 555mm Depth: 475mm

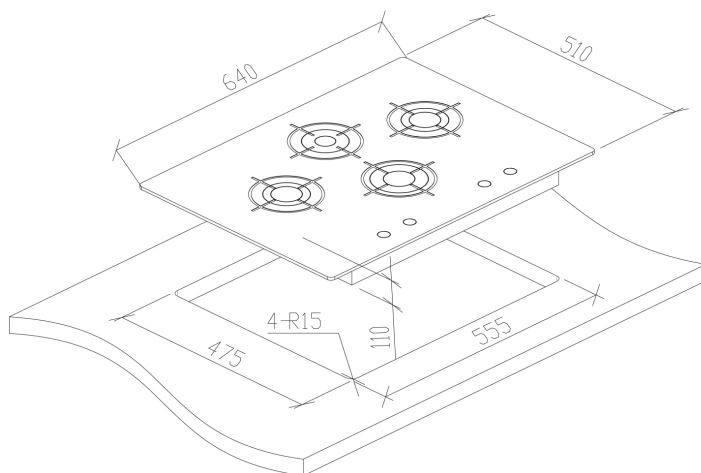



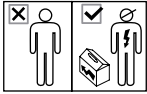

All installation work must be carried out by a competent person or qualified electrician. Before connecting the mains supply ensure that the mains voltage corresponds to the voltage on the rating plate inside the cooker hood.

**Warning: THIS APPLIANCE MUST BE EARTHED.**

Mains Supply could be connected to the Mains Voltage by Direct Connection

DOUBLE POLE SWITCHED  
FUSED SPUR OUTLET

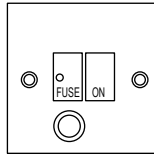

USE A 3AMP FUSE

### Direct Connection

If the appliance is being connected directly to the mains an omnipolar circuit-breaker must be installed with a minimum opening of 3mm between contacts.

If the cable is damaged or to be replaced, the operation must be carried out by a qualified electrician with dedicated tools to avoid any accidents.

The installer must ensure that the correct electrical connection has been made and that it complies with wiring diagram.

The cable must not be bent or compressed.

The cable must be checked regularly and replaced by authorized technicians only.

## Electrical Requirements

Any permanent electrical installation must comply with the latest I.E.E. Regulations and local electricity company regulations. For your own safety a qualified electrician or contractor who is on the roll of the National Inspection Council for Electrical Installation Contracting (NICEIC) should undertake the electrical installation.

## Electrical Connection

Before connecting the mains supply ensure that the mains voltage corresponds to the voltage on the rating plate inside the appliance.

### **WARNING: THIS APPLIANCE MUST BE EARTHED**

The appliance is supplied with a 3-core mains cable and must be connected to the electricity supply via a double pole switch having a 3mm minimum contact gap on each connector.

For UK only  
A Switched Fused Connection Unit to BS 1363 Part 4 is recommended.

**The fuse must be rated at 3 Amps.**

The wires in the mains lead are coloured in accordance with the following code:

**Brown = L - Live**

**Blue = N - Neutral**

**Green/Yellow = ⊕ - Earth**

The connection point must be placed in a position adjacent to the appliance so as to be readily accessible for an engineer in the event of a breakdown.

**Disconnect the appliance from the mains supply before carrying out any kind of maintenance or cleaning.**

## Installation Guidelines

### Gas Supply Requirements (UK and ROI)

This installation must comply with the Gas Safety Regulations 1984.

The connection to the gas supply must comply with all current regulations in force.

We are not legally able to offer advice on the installation of gas appliances to non Gas Safe registered personnel.

#### Ventilation

All rooms require a window or equivalent (e.g. a door) which can be opened. Some rooms require a permanent vent or extractor in addition to a window (see below).

This unit must not be used in a room which is less than 5m<sup>3</sup>.

The following table details the requirements based on the kitchen volume (L x W x H) in m<sup>3</sup>.

The above requirements also allow use of a gas oven and grill but if there are any other fuel burning appliances in the same room, consult the relevant British Standard (BS5440) or Gas Safe manual.

Room Volume (m <sup>3</sup> )A	Air vent required (cm <sup>3</sup> )
5	100
6 to 10	50
6 to 10	No permanent vent required if a door opens to the outside
11 or more	None required

The above requirements also allow use of a gas oven and grill but if there are any other fuel burning appliances in the same room, consult the relevant British Standard (BS440) or Gas Safe document.

### What you should do if you smell gas?

- Switch off the gas supply
- Open doors and windows
- Call Transco 0800 111 999

## Gas connection

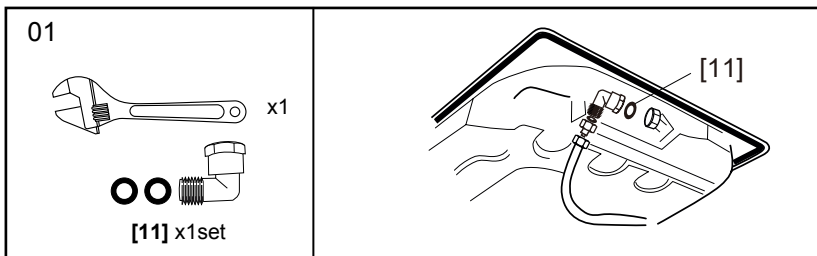

### Changing the nozzles



#### Caution

The hob installation and burner changes must be carried out by a competent person, ie a Gas Safe registered fitter.

NOTE: The LPG nozzles are provided in a separate bag marked “LPG” and if they are changed and the natural gas jets retained then the label should be changed to “NATURAL”.

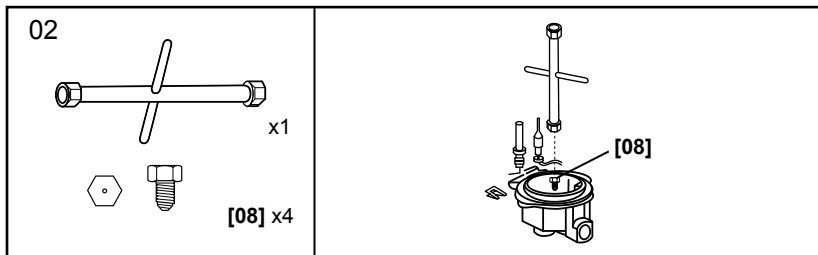

Lift up the burners and unscrew the nozzle using an dedicated tool and replace the nozzles with those designed for LPG gas supply.  
(see table on page 16)

Note: When the injectors have been changed the gas technician should mark the appliance to show which injectors are being used.

## Regulation of burners



### Caution

The regulation described can only be carried out with burners that use methane gas and city gas (where available), whereas the screw must be fully tightened in a clockwise direction on burners using liquid gas.

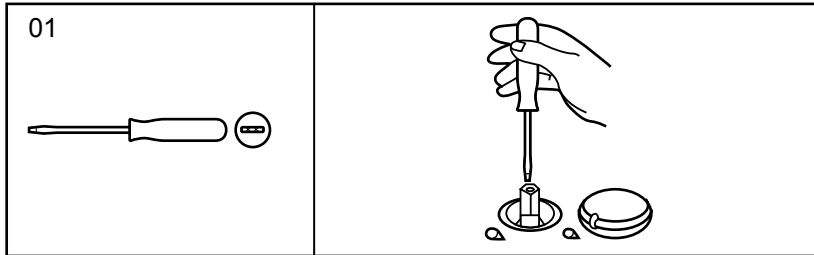

Regulation of the “mINImUm” position on the burners.

To regulate the minimum position on the burners, follow the procedure below:

1. Turn on the burner and turn the knob to its mINImUm position (small flame)
2. Remove the knob from the tap set for standard pressure. The knob is found on the bar of the tap itself.
3. Place the tap bar on the work top, use a small screwdriver that fits the (gold) screws located at the lower part of the tap and turn the fixing screw to the right or left until the flame of the burner is regulated in the most suitable manner to mINImUm.
4. Make sure that the flame does not go out when changing the position quickly from mAXImUm to mINImUm position.

## **GAS CONNECTION**



### **CAUTION**

THE GAS CONNECTION MUST BE INSTALLED IN COMPLIANCE WITH APPLICABLE REGULATIONS IN THE COUNTRY OF INSTALLATION.

The preferred method of connection is by rigid copper pipe or by flexible hose, depending on local regulations. The hob is supplied with a G $\frac{1}{2}$ " elbow that can be used or discarded depending on approved method of connection and best engineering practice.

### **STANDARDS**

**UK:** Gas safety (Installation and use) Regulations 1998

**France:** Bottled Gas NF D 36-125  
Gas Network NF D 36-121

The Manufacturer has a policy of continuous product improvement, it reserves the right to adapt and carry out any modification considered necessary without prior warning.

**Appendix...**

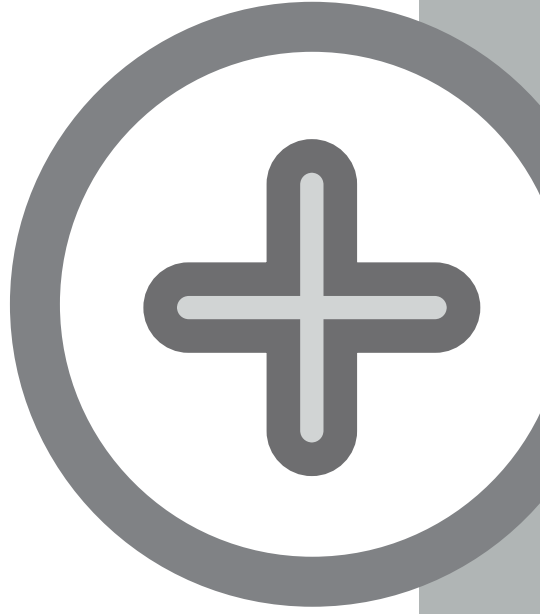

## Clearance



### Warning

Good ventilation is required around the appliance for easier dissipation of heat and low power consumption. Sufficient clearance is required around the appliance. The gap between the hob and any cupboard above it should be at least 750mm.

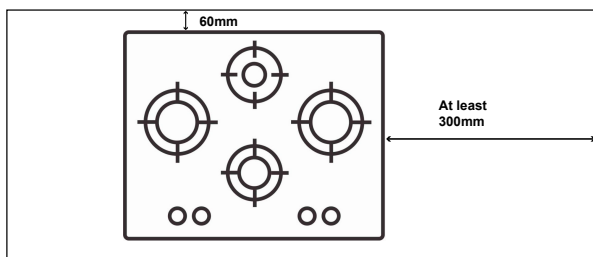
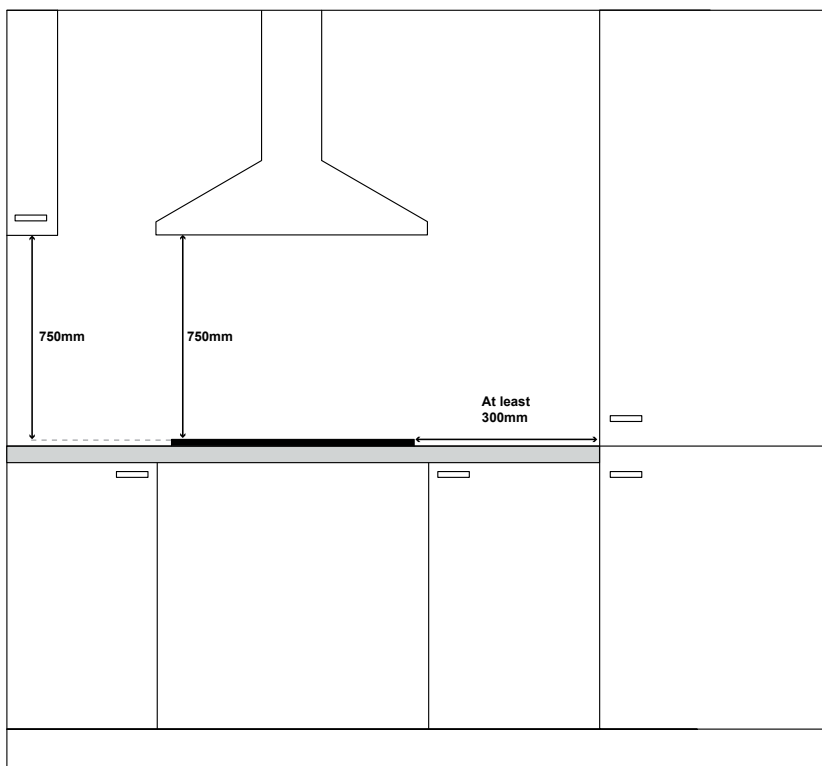



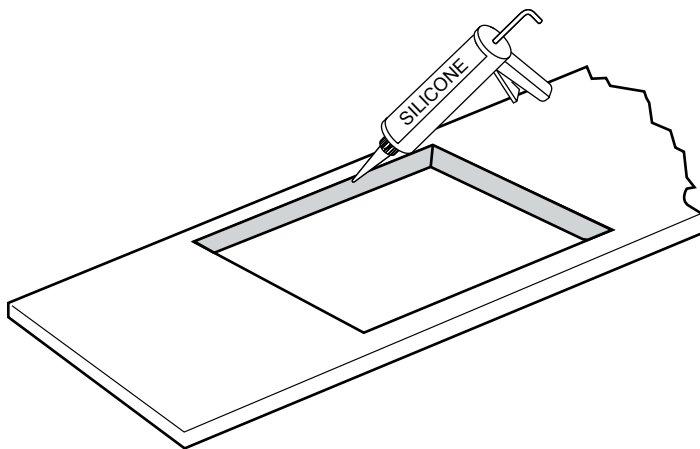

01



[10] x 1



Cut out worktop to the template dimensions with suitable equipment and seal the cut edge with appropriate sealant.

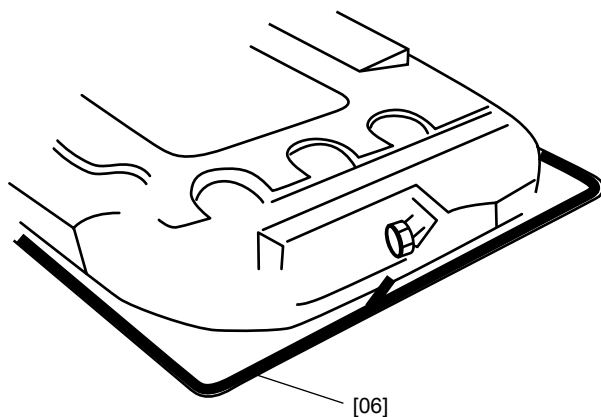

02

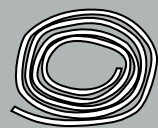

[06] x 1

Stretch out the supplied seal along the underside edge of the hob, ensuring the ends overlap.

## 03

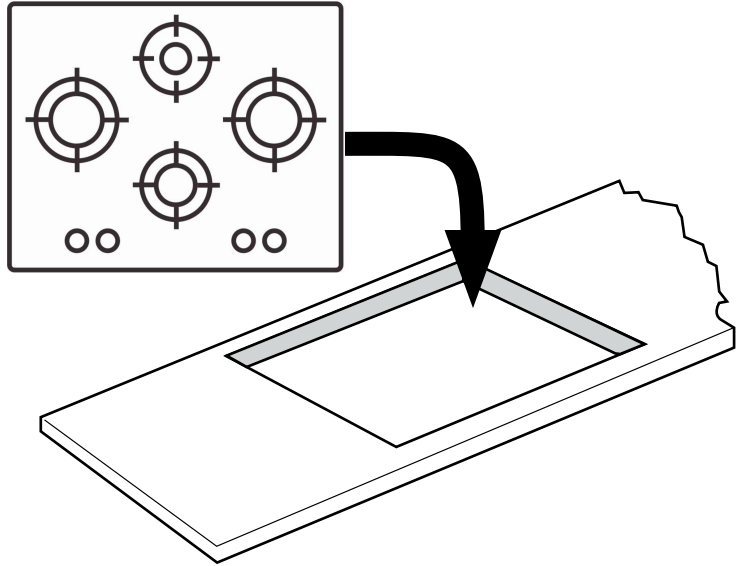

## 04



[07] x 4



[09] x 4

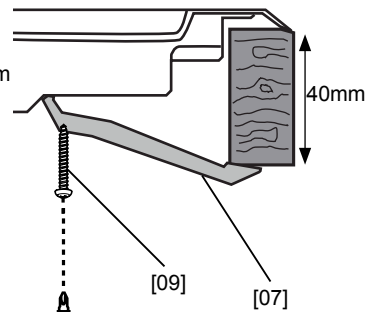
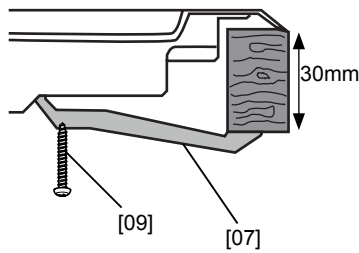

Note: The images above are a guide only.

**Note:** For electrical connection see **Technical and legal information** section





Apelson Appliances UK Ltd  
Unit 3 Normandy Landings  
Pope Street  
Castleford  
WF6 2AG  
United Kingdom

5.5.0000052 29.08.2017