

INSTRUCTION MANUAL

Electric Fires & fireplace suites*



This product is only suitable for well insulated spaces or occasional use.

*This manual is used for a variety of products. Please make sure you follow the appropriate product guide lines. Illustrations are for reference only.

www.firedupcorporation.com/manual

Read ALL the instructions before use.

This manual is used for many different products. Please make sure you follow the appropriate product guide lines. Please refer to the front page for reference.

These instructions are for your safety. Please read through them thoroughly before use and retain for future reference. Failure to follow them could cause injury and/or property damage.

CONTENTS

SECTION 01

| | |
|--------------|-------|
| Cautions | 03-06 |
| Introduction | 06 |
| Handling | 06 |

SECTION 02

| | |
|--------------------------------|-------|
| Unpacking & Care | 07 |
| Fitting the trim | 07 |
| Adding the pebbles | 07 |
| Installing the fire | 08-09 |
| Installing the fireplace | 08-09 |
| Remote control & Control panel | 09-10 |

SECTION 03

| | |
|--|-------|
| Getting started & pairing the remote control | 11 |
| Operation | 11-15 |
| Reset settings & Additional features | 16 |
| Plug replacement | 17 |
| Technical parameters | 18 |
| Specification, Conformity & Environment | 19 |
| Guarantee & Contacts | 20 |

CAUTIONS

DO'S

- Read ALL the instructions before using this product.

- Only use this product for its intended use as described in this manual.

- Always use the product in accordance with this guide. If in doubt obtain expert advice.

- Always check your mains supply is the same as that indicated on the product before connecting.

- Always make sure the electrical socket is accessible.

- Always disconnect the heater from the electrical supply before carrying out cleaning or maintenance. To disconnect the heater, switch controls to OFF then remove plug from the outlet.

- Ensure the floor space is flat and even.

DON'TS

- Never leave children unsupervised in a room where the fire is ON and unguarded.

- Never obstruct or cover the fan outlet or force items into fire openings.

- Never use the product anywhere where water is in use, i.e. bathrooms, kitchens, shower rooms, and swimming pool etc.

- Never use aerosols or steam cleaners on or around the fire.
-
- Never route the supply cord under carpeting and never cover the cord with throw rugs, runners, etc. Arrange the cord away from traffic areas and where it will not be tripped over.
-
- Never place the heater close to curtains or combustible materials. Keep furniture, bedding, papers, clothes, curtains, etc. at least 1m away from the front of the heater and keep away from the sides and rear.
-
- Never use the product to dry clothes etc.
-
- Never sit or stand on the product.
-
- Never lean or put weight on the product.
-
- Do not use outdoors.
-
- Do not sit the product on deep pile carpets or rugs.
-

Avoid the use of an extension cord which may overheat and cause risk of fire. If an extension cord is necessary, it must be rated above the maximum rated power of the appliance. Care must be taken to arrange the cord so that it cannot be pulled or be tripped over.

IMPORTANT!

- This appliance can be used by children aged from 8 years and above and persons with reduced physical, sensory or mental capabilities or lack of experience and knowledge if they have been given supervision or instruction concerning use of the appliance in a safe way and understand the hazards involved.
- Children shall not play with the appliance.
- Cleaning and user maintenance shall not be made by children without supervision.
- If the supply cord is damaged, it must be replaced by the manufacturer, its service agent or similarly qualified persons in order to avoid a hazard.



WARNING: In order to avoid overheating,
DO NOT COVER THE HEATER

- The heater must not be located immediately below a socket outlet.
- Children of less than 3 years should be kept away unless continuously supervised.
- Please note the LED bulb in the appliance is non replaceable, do not attempt to replace it.
- Children aged from 3 years and less than 8 years shall only switch on/off the appliance provided that it has been placed or installed in its intended normal operating position and they have been given supervision or instruction concerning use of the appliance in a safe way and understand the hazards involved. Children aged from 3 years and less than 8 years shall not plug in, regulate and clean the appliance or perform user maintenance.

- **CAUTION** — Some parts of this product can become very hot and cause burns. Particular attention has to be given where children and vulnerable people are present.
- This heater is hot when in use. To avoid burns, do not touch hot surfaces such as surfaces around the grille in front of the heater. Never let bare skin touch hot surfaces.
- Do not use this heater in the immediate surroundings of a bath, a shower or a swimming pool.

Note: When the heater is turned on for the first time or when it has not been used for some time, it may release a slight, harmless odour. This odour is a normal occurrence caused by the initial heating of the internal heating elements and will disappear with use.

INTRODUCTION

Thank you for choosing this product. It is designed to meet the most stringent quality, performance, and safety requirements. This guide aims to improve your understanding and appreciation of your new product by providing simple and informative instructions.

HANDLING

Before continuing any further with the installation of this product please read the following:

- When lifting always keep your back straight. Bend your legs and not your back.
- Avoid twisting at the waist. It is better to reposition your feet.
- Avoid upper body / top heavy bending. Always bend from the knees rather than the waist.
- Do not lean forward or sideways whilst handling the product.
- Always grip with the palm of the hand. Do not use the tips of fingers for support.
- Always keep the product as close to the body as possible. This will prevent unnecessary and undue strain on the body.
- Use gloves to provide additional grip.
- Always use assistance if required.

UNPACKING

The unit is supplied in a single package carton. Carefully unpack the product using the following procedure:

- Carefully lift the parts out of the box
- Carefully remove the protective wrapping from the parts
- Locate the instruction manual and put aside
- Carefully remove the product from its box and put aside

CARE

- Brushed stainless steel can be cleaned using a cloth and propriety cleaner.
- Fires with a glass screen can be cleaned using a cloth and propriety cleaner.
- Other features (non-silver) can be cleaned using a damp cloth.
- If the supply cord is damaged, it must be replaced by a suitably qualified person.
- The area around the fire should be kept free from animal hair, lint and other extraneous material that may be drawn into the workings of the appliance which could affect its performance.

FITTING THE TRIM

Some fires come supplied with a trim fitted to the fire. Others are either supplied with the product or separate to the product.

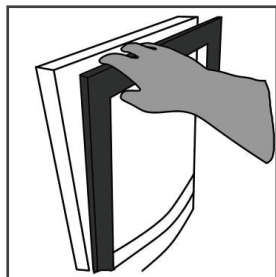

For those supplied separate to the product, please refer to the instructions supplied with the trim.

For those that are supplied with the product please locate the trim and remove the packaging. Be aware that there are magnets on the back of the trim. Offer the trim up to the fire and attach as shown.

ADDING THE PEBBLES

Some fires come supplied pebbles. Simply remove the packaging and randomly place the pebbles to the fuel bed area, starting with the larger pebbles first. To enhance the effect, turn the effect on to see how the light shines between each pebble and try to make the size of the space even.

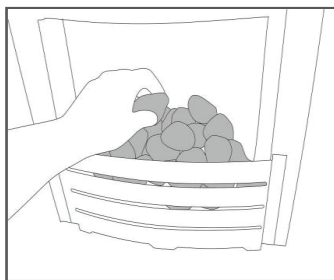

INSTALLING the fire (Not applicable for fully assembled fireplace suites)

Minimum distances required

When installing the fire the following amount of space must be left around the fire (minimum). Make sure the appliance's air inlets are not blocked.

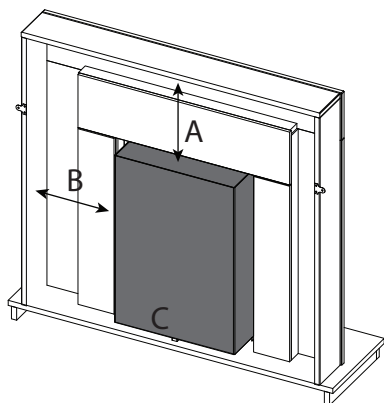

A: >37cm

B: >28cm (both sides of fire)

C: >1.3cm (between fire and wall)

This fire is suitable to fit into surrounds with an opening of W42cm x H57cm (16.5" x 22.5").

Fitting the fire to wooden back panels

1. Remove the 6* screws around the edge of the fire to detach the spacer as shown.
2. Using 6* of 3.5mm x 12mm screws (not supplied) fit the spacer to the back panel.
3. Mark & pre-drill through the spacer holes first.
4. When the spacer is attached to the back panel reattach the fire to the spacer with the previously removed screws.

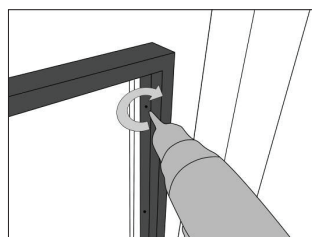
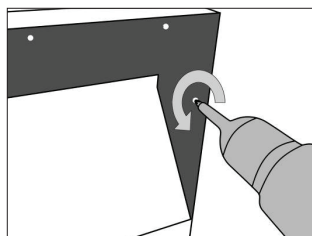

* On some fires its 8 screws

Fitting the fire to a stone back panel

1. Stick one side of the Neoprene Strip (x3) to the back of the electric fire as shown.
2. Position the fire within the surround, then peel back the other side of the Neoprene Strips.
3. Gently push the fire in to position.

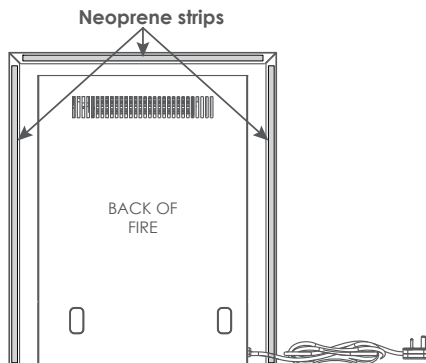

INSTALLING the fireplace (Not applicable for inset fires)

Fixing kit supplied with fireplace suites only

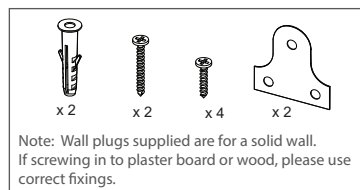

1. Fix the metal plate to the back of the fireplace as shown using the 4 x small screws supplied.
(It is recommended to drill a 2mm pilot hole to prevent the wood splitting.)
2. Position the fireplace to the wall and mark through the 2 remaining holes.
3. Remove the fireplace then drill 6mm diameter holes approximately 35mm deep. Insert the wall plugs.
4. Position the fireplace to the wall then screw through the plates in to the wall using the 2 x large screws provided.

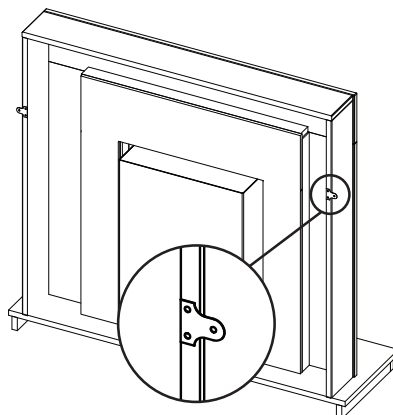

REMOTE CONTROL

This product is supplied with a remote control. If this is lost or broken, please contact the manufacturer for a replacement. Contact details are on the back page. Without the remote control the fire will only be able to operate with basic functions i.e flame effect/1kW heat/2kW heat.

Remote control

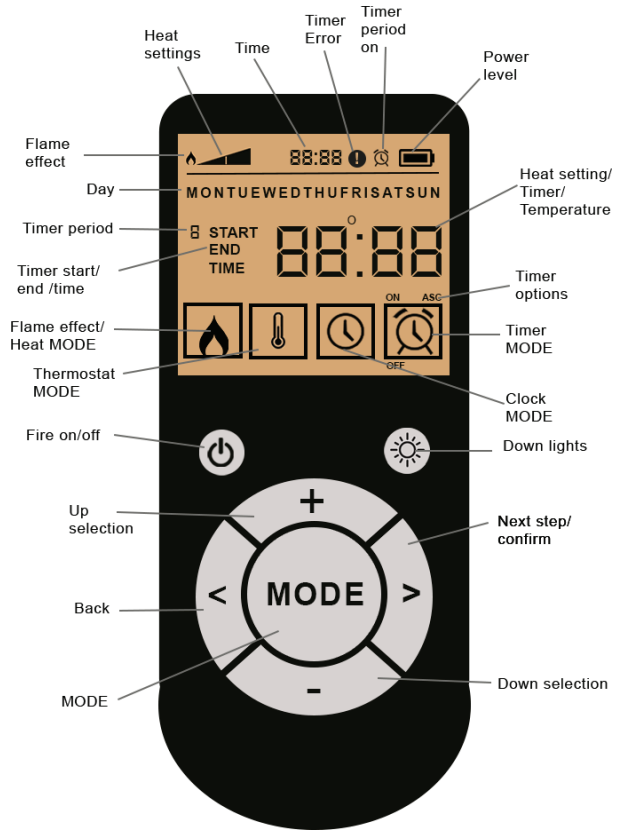

! Timer Error - Displays when the END time is set before start time. Also displays when 2 or more timer periods overlap.

🕒 Timer period on - Displays when a timer period is active.

Control panel

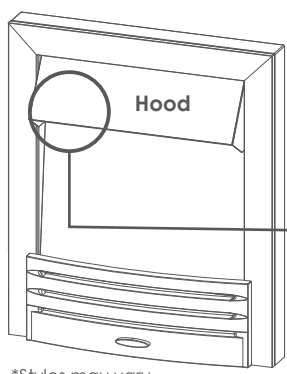

*Styles may vary

The control panel can be located below the hood.

On some electric fires, the control panel is located by lifting up the hood.

SWITCHES

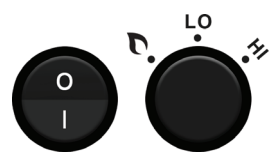

Power switch

Function button

- Flame effect - 1 beep
- LO heat (1kW) - 2 beeps
- HI heat (2kW) - 3 beeps

OPERATION - Manual

Press 'function button' to cycle through the **Flame Effect, Heat Setting 1 and Heat Setting 2.**

(The thermostat and timer settings cannot be programmed using the manual controls.)

OPERATION - Remote control

Insert 2 x AAA batteries to the back of the remote control. Turn the power switch on.

Pairing the remote control

The remote uses wireless technology.

To pair the fire with the remote control follow the below procedure:

1. Turn on the 'power switch' located under the hood of the fire. A beep will sound.
2. Press and hold the 'function button'. A beep will sound.
3. Within 10 seconds, press  on the remote control (when the screen is illuminated. If it is not illuminated, press twice.) It will beep 10 times to confirm it is connected. (If pairing is unsuccessful, it will beep 5 times.)

Note: The remote control functions can only be used when the screen is active (illuminated). Press any button except  to activate the display.

Turn on flame effect & heat

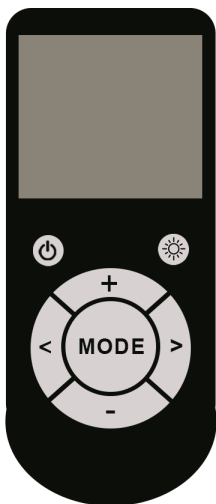

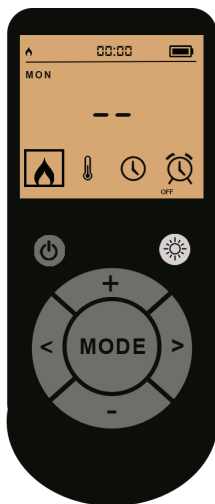

The above screen shows the remote control in 'standby'

When the remote has not been used for 15 secs, the remote control will go in to 'standby.'





Press any button except  to activate the display.

 will be shown

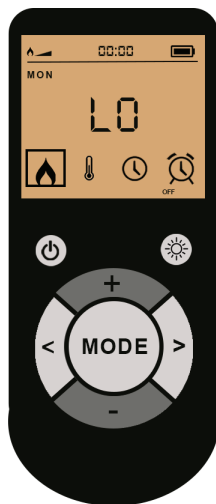
IF  is pressed, the fire will turn on to the last heat setting.



Press + or - to select flame effect and heat settings.

-  Flame effect only
-  Flame effect & heat setting 1
-  Flame effect & heat setting 2

Note: The remote control functions can only be used when the screen is active (illuminated). Press any button except  to activate the display.

Set thermostat (5° - 30° C)

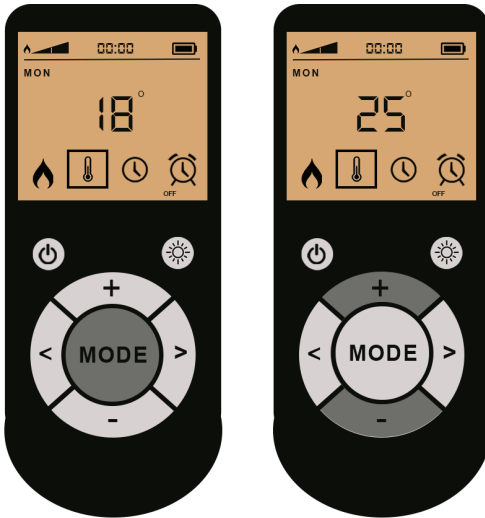

After activating the display, Cycle through MODE to select.



Press + or - to increase or decrease the desired room temperature.

(IF the desired room TEMP is lower than the actual room TEMP, then flame effect only will turn on.)

(IF the desired room TEMP is higher than the room TEMP, then heat will turn on.)

Down lights*



Press  turn the downlights on and off.

* On selected models only

Note: The remote control functions can only be used when the screen is active (illuminated). Press any button except  to activate the display.

Set day & time



After activating the display, Cycle through MODE to select.



DAY will flash.

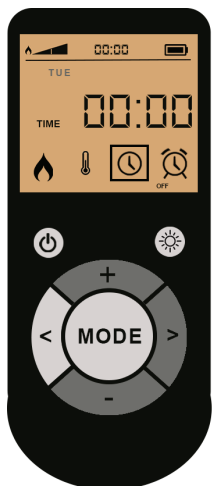

Press + or - to select DAY

Press > to go to next step

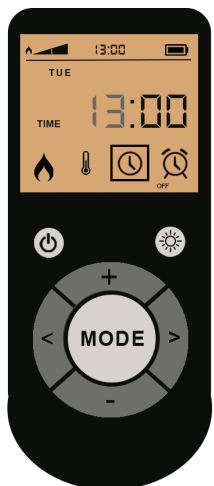

HOUR will flash

Press + or - to select HOUR

Press > to go to next step

OR

Press < to go back a step

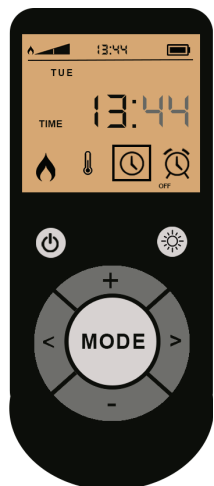

MIN will flash

Press + or - to select MIN

Press > to go to next step

OR

Press < to go back a step

Note: The remote control functions can only be used when the screen is active (illuminated). Press any button except  to activate the display.

Set timers



SET ALL TIMERS ON/OFF:

After activating the display, cycle through MODE to select.



OFF will flash.

Press + or - to select timer options:

OFF - All timers off

ON - All timers on

ON ASC - All timers on with 'Adaptive Start Capability' (See page 16 for more information)

Press > to go to next step.

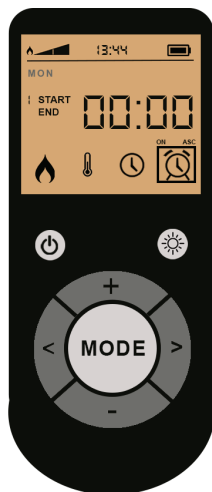

SET DAY:

DAY will flash.

Press + or - to set DAY.

Press > to go to next step
OR

Press < to go back a step.

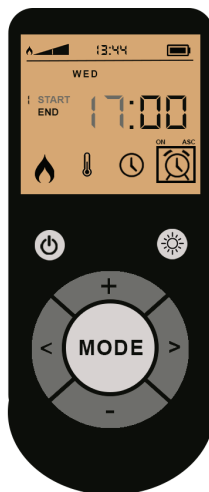

SET period 1 START time:

START & HOUR will flash.

Press + or - to set HOUR

Press > to go to next step
OR

Press < to go back a step.



SET period 1 START time:

START & MIN will flash.

Press + or - to set MIN

Press > to go to next step
OR

Press < to go back a step.

Note: The remote control functions can only be used when the screen is active (illuminated). Press any button except  to activate the display.

Set timers cont....

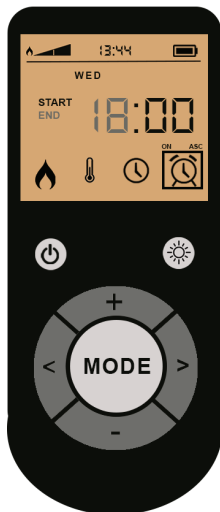

SET period 1 END time:

END & HOUR will flash.

Press + or - to set HOUR

Press > to go to next step
OR
Press < to go back a step.



SET period 1 END time:

END & MIN will flash.

Press + or - to set MIN

Press > to go to next step
OR
Press < to go back a step.

**REPEAT process to set
period 2 START & END times.**

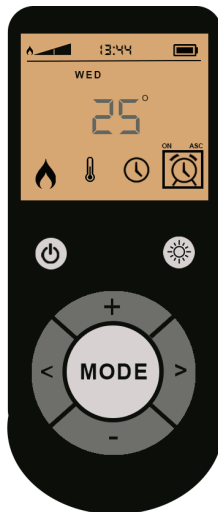

SET desired TEMP:

TEMP will flash.

Press + or - to set TEMP

Press > to go to next step
OR
Press < to go back a step.

**REPEAT process to set
the rest of the week**

Reset settings



Note: The remote control functions can only be used when the screen is active (illuminated). Press any button except  to activate the display.

Default settings

Timers - OFF
 Timers times set: Day - Mon / All 00:00 - 00:00
 Temperature: 18°C
 Open window/door detection: OFF
 Time - Not affected

Press and hold + and - for 3 seconds.
 It will beep 3 times.

All functions except 'Time' will reset back to default settings.

ADDITIONAL FEATURES

This product has the following features that have been tested in room sizes up to 25msq. The parameters may vary between different room sizes.

ASC (Adaptive Start Capability) - This allows the fire to calculate the optimum start time to reach the desired temperature set in the timer function.

For example: If the fire was set to start at 10am with the thermostat set at 25 degrees, and the room temperature was 20 degrees, the fire will calculate when to start to reach 25 degrees by 10am.

Open Window/Door Detection - If the heat is turned on and the room temperature drops, the heater automatically turns off (and beeps). The heater can be turned back on by pressing  or + or - .

To turn on hold 'MODE' & < together for 3 seconds. The fire will beep twice and display

To turn off, repeat the above process. The fire will beep twice and display   

PLUG REPLACEMENT

(for products fitted with BS plug)

This appliance is supplied with a BS1363 3 pin plug fitted with a 13 Amp fuse. Should the fuse require replacement, it must be replaced with a fuse rated at **13 Amp** and approved to BS1362.

In the event the mains plug has to be removed/replaced for any reason, please note:

The wires in the mains lead on this appliance are coloured in accordance with the following code:

Green and Yellow - Earth
 Blue - Neutral
 Brown - Live

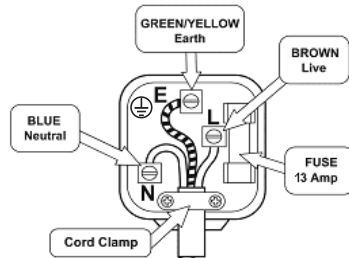

THIS APPLIANCE MUST BE EARTHED

As the colours may not correspond with the markings identifying the terminals in your plug proceed as follows.

- The green and yellow earth wire must be connected to the terminal in the plug which is marked with the letter E or with the earth symbol (⊕)
- The blue wire must be connected to the terminal marked N
- The brown wire must be connected to the terminal marked L

Important - any cut off plug should be disposed of safely to prevent hazard. There is a danger of electric shock if a cut off plug is inserted into a socket outlet.

TECHNICAL PARAMETERS

Information requirements for electric local space heaters

| Item | Symbol | Value | Unit | Item | Unit |
|--|--|-------|------|---|----------|
| Heat output | | | | Type of heat input, for electric storage local space heaters only (select one) | |
| Nominal heat output | P_{nom} | 2 | kW | manual heat charge control, with integrated thermostat | [yes/no] |
| Minimum heat output (indicative) | P_{min} | 1 | kW | manual heat charge control with room and/or outdoor temperature feedback | [yes/no] |
| Maximum continuous heat output | $P_{max,c}$ | 2 | kW | electronic heat charge control with room and/or outdoor temperature feedback | [yes/no] |
| Auxiliary electricity consumption | | | | fan assisted heat output | [yes/no] |
| At nominal heat output | e_{max}^I | N/A | kW | Type of heat output/room temperature control (select one) | |
| At minimum heat output | e_{min}^I | N/A | kW | single stage heat output and no room temperature control | [yes/no] |
| In standby mode | e_{SB}^I | 0 | kW | Two or more manual stages, no room temperature control | [yes/no] |
| | | | | with mechanic thermostat room temperature control | [yes/no] |
| | | | | with electronic room temperature control | [yes/no] |
| | | | | electronic room temperature control plus day timer | [yes/no] |
| | | | | electronic room temperature control plus week timer | [yes/no] |
| | | | | Other control options (multiple selections possible) | |
| | | | | room temperature control, with presence detection | [yes/no] |
| | | | | room temperature control, with open window detection | [yes/no] |
| | | | | with distance control option | [yes/no] |
| | | | | with adaptive start control | [yes/no] |
| | | | | with working time limitation | [yes/no] |
| | | | | with black bulb sensor | [yes/no] |
| Contact details | Name and address of the manufacturer or its authorised representative. See back page | | | | |

The seasonal space heating energy efficiency of all local space heaters except commercial local space heaters η_S (%): 38

SPECIFICATION

| | | |
|----------------|---|--------------------------------|
| Supply Voltage | - | 220-240V~50Hz |
| Rated Power | - | 2000W |
| Fuse Rating | - | 13 Amp |
| Lighting | - | 5W LED Array (non serviceable) |
| Class | - | 1 |

CONFORMITY WITH DIRECTIVES

Conforms with relevant European Directives

ENVIRONMENTAL PROTECTION

- (WEEE) Waste Electrical and Electronic Equipment

Waste electrical products should not be disposed of with household waste. Please recycle where facilities exist. Check with your Local Authority or retailer for recycling advice.

- This appliance complies with the RoHS directive which restricts the use of certain hazardous substances in electrical and electronic equipment. This directive bans the placing on the EU market of new electrical and electronic equipment containing more than agreed levels of lead, cadmium, mercury, hexavalent chromium, polybrominated biphenyl (PBB) and polybrominated diphenyl ether (PBDE) flame retardants.



GUARANTEE

For your convenience, you are not required to complete a form and return it to us in order to validate your guarantee. However, please ensure that you retain your receipt which will act as both proof of purchase and a guarantee validation document. **We recommend that you attach your receipt to this documentation.**

Your product carries a 12 month guarantee from the date that the original purchaser receives it. If your product fails to operate to its specification due to faulty workmanship or materials during the guarantee period, we will either repair or replace the product. We will use our discretion to determine whether to offer a repair or provide a replacement. The product will not be covered by the guarantee if it has been misused, transformed, modified or altered in any way.

If your product fails within the guarantee period please ensure that you have all necessary documentation available including proof of purchase (receipt or invoice with serial number, location and date of purchase) in addition to all original undamaged packaging and leaflets etc. It is strongly recommended that you inspect your product carefully before it is used or installed. For full details of your product you should refer to the instruction manual which accompanies the product. You are strongly advised to read this manual carefully in its entirety and to retain it for future reference.

This product guarantee does not affect your statutory rights.

CUSTOMER HELPLINE

 03300 882 069

 customer.support@firedupcorporation.com



www.firedupcorporation.com

Fired Up Corporation Ltd.
Fired Up Buildings
St Thomas Road
Huddersfield
HD1 3LF
United Kingdom
