

UK



**MODELS: Fuego Manual / Remote Option  
Fuego LE Timer fires  
Installation and User Instructions**



**PLEASE READ THESE INSTRUCTIONS CAREFULLY  
AND RETAIN FOR FUTURE REFERENCE**

This electric fire has been made with great care. Here are some instructions including cleaning and maintenance, which will help you keep your fire in good condition for many years. If you experience any parts or service problems contact your retailer.

This appliance is not intended for use by persons (including children) with reduced physical, sensory or mental capabilities, or lack of experience and knowledge, unless they have been given supervision or instruction concerning use of the appliance by a person responsible for their safety.

Children should be supervised to ensure that they do not play with the appliance.

This is an amendment to the standard and now applies to all EN60335 or later approved products.

**WARNING - DO NOT BLOCK ANY AIR VENTS.**

**DO NOT TURN THE FIRE ON UNTIL YOU HAVE READ ALL OF THE INSTRUCTIONS.**

*Created in the UK by*

**WIDNEY LEISURE LTD**

St Marys Road, Nuneaton, Warwickshire, CV11 5AU

Telephone: +44(0) 2476 377550

Email: [sales@widney-leisure.co.uk](mailto:sales@widney-leisure.co.uk) | Web: [www.widney-leisure.co.uk](http://www.widney-leisure.co.uk)

The product complies with the European Safety Standards EN 60335 -1, EN60335-2-30 and the essential requirements of EEC Directives 73/23 and 89/336



# **YOUR FIRE**

## **UNPACKING, ELECTRICAL INSTALLATION & GENERAL SAFETY**

### **GENERAL:**

Unpack the fire carefully and retain the packaging for possible future use, for example in the event of moving or returning the fire to your supplier. Remove any plastic protection film and transit tape.

The fire incorporates a flame effect that may be enjoyed at any time of the year; using the flame effect on its own only requires minimal electricity.

### **THIS APPLIANCE MUST BE EARTHED**

Check that the voltage shown on the rating label of your fire is the same as your dwelling electricity supply which must be AC (alternating current).

The mains cord of the fire has a UK type plug fitted with a 13amp fuse; when replacing a fuse use a 13amp fuse approved to BS 1362. The fuse cover of a moulded on plug must be refitted after changing the fuse. Should the fuse cover become lost, the plug must not be used until the correct replacement fuse cover is obtained from your service agent.

The wires in the mains supply cord are coloured in accordance with the following code: Green and Yellow = Earth, Blue = Neutral, Brown = Live.

If your fire is fitted with a moulded on mains plug which is not suitable for the socket outlets in your dwelling, the plug must be cut off and an appropriate one fitted.

Note: A plug cut off from a flexible cord presents a shock hazard if inserted in a 13 amp socket elsewhere in the dwelling, to avoid this remove the fuse and dispose of immediately.

If you are fitting an alternative type of plug then the colours of the wires in the mains cord may not correspond with the identifying markings on the plug terminals. In this case proceed as follows:

The wire which is coloured Green/Yellow must be connected to the terminal in the plug which is marked by the letter E or by the earth symbol or coloured Green or Green/Yellow. The wire which is coloured Blue must be connected to the terminal in the plug which is marked by the letter N or coloured Black. The wire which is coloured Brown must be connected to the terminal in the plug which is marked by the letter L or coloured Red.

- **ALWAYS INSTALL THE FIRE SO THAT THE PLUG IS ACCESSIBLE.**
- **DO NOT COVER OR HANG CLOTHES, TOWELS ETC. OVER OR NEAR THE HEATER AS THIS COULD CAUSE OVERHEATING AND POSSIBLE DAMAGE. THE HEATER SHOULD NOT BE USED IMMEDIATELY BELOW A SOCKET OUTLET.**
- **DO NOT USE IN THE IMMEDIATE SURROUNDINGS OF A BATH, SHOWER OR NEAR ANY SOURCE OF WATER.**
- **ENSURE THAT SUFFICIENT CABLE LENGTH IS FITTED TO ENABLE THE MAINS PLUG TO BE CONNECTED TO THE APPLIANCE WITHOUT STRETCHING.**
- **DO NOT USE THIS HEATER WITH AN EXTERNAL PROGRAMME CONTROLLER, THERMAL CONTROL, TIMER OR ANY OTHER DEVICE WHICH SWITCHES THE HEATER ON AUTOMATICALLY AS A FIRE RISK MAY OCCUR IF THE HEATER HAS BEEN ACCIDENTALLY COVERED OR MOVED.**

### **HARD WIRING THE FIRE:**

IF DESIRED THE FIRE CAN BE HARD WIRED TO A SWITCHED FUSED ISOLATOR.

IF A SWITCH FUSED ISOLATOR IS USED ENSURE THAT THE FUSE IN THE ISOLATOR IS RATED AT 13AMP TO BS1362.

It is recommended that this work be undertaken by a competent engineer.

Note: If the fire is hard wired ensure that the mains lead can be unplugged from the appliance to assist removal.

# SECTION 1: ELECTRIC FIRE FITTING INSTRUCTIONS

The appliance can either be fixed to a flat vertical wall or inset – please refer to the instructions below.

## WARNING

DO NOT BLOCK ANY OF THE AIR VENTS LOCATED IN THE BACK, SIDES OR THE FRONT OF THE FIRE

### FLAT WALL FIXING:

The appliance should be securely fixed to the wall using suitable wall fixings.

1. Position the hanger bar at the desired height: note that the minimum height to the top of the fixing bracket from the floor must be at least 565mm to ensure there is a minimum of 60mm air gap between the floor and the fire.
2. Mark the position of the hanging bar on the wall - ensure that it is parallel to the floor.
3. Mark fixing holes through hanger bar and drill holes to suit wall fixings and screws.
4. Fix hanger bar to wall using suitable fixings.
5. The main chassis of the fire is now ready to be fitted.
7. Connect the mains cord to the fire
8. At the top of the fire is a hanging lip that is designed to fit over the lip on the hanger bar; hang the fire onto this lip.
9. To fix the fire permanently to the wall there is a tab at the rear of the fire on the bottom right hand side (viewed from the front) shown in the diagram (right) that should be used. The tab should be unfolded out as shown in the diagram and then used to insert the fixing the same as those used for the wall hanger bar.
10. The Fascia may now be fixed to the fire chassis – see Fully inset instructions 'Fitting the fascia'.

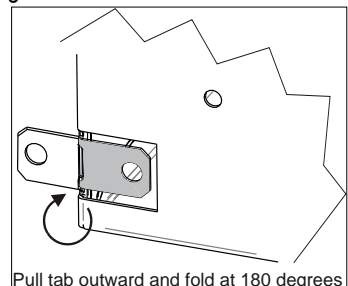
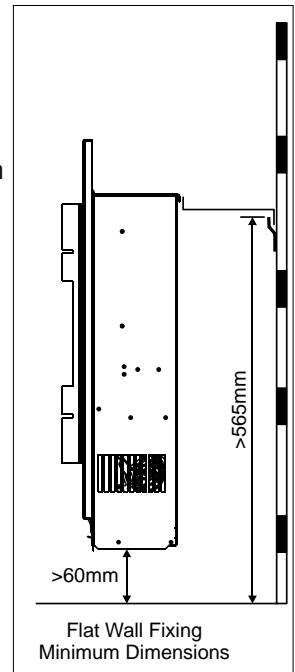

## **FULLY INSET FITTING:**

The fire can be inset up to the fixing flange as indicated in the diagram.

## **IMPORTANT:**

- IT IS IMPORTANT TO PROVIDE SUFFICIENT AIR TO THE CAVITY BEHIND THE APPLIANCE. THE RECOMMENDED MINIMUM IS 12,600MM<sup>2</sup>.
- THE FIRE MUST BE FITTED WITH A MINIMUM OF 50MM CLEARANCE BETWEEN THE REAR OF THE FIRE AND ANY SOLID WALL.

## **Fitting the fire into a wall or aperture:**

The fire should be fitted in an aperture cut to the size shown in the diagram; the cavity depth should also be as shown – if the depth is less than shown the fire may not function correctly.

## **Installation of the fire:**

Provision for a mains connection should be made at the rear of the aperture – If the appliance is to be hard wired allow sufficient length of mains cable to enable removal of the appliance from the aperture with the cable attached.

11. Fix the mains cable to the underside of the appliance
12. Slide the fire into the aperture
13. Check to ensure that the appliance is level.
14. Mark through the fixing holes in the outer flange and then remove the fire from the wall aperture.
15. Drill the wall with a suitable sized drill and where necessary insert suitable fixings.
16. Connect the appliance to the mains socket.
17. Slide the complete fire into the aperture.
18. Fix the fire to the pre drilled holes with suitable fixings.

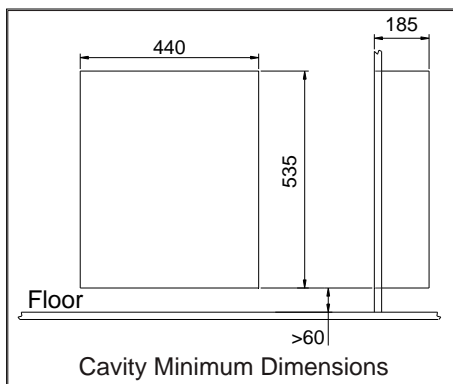
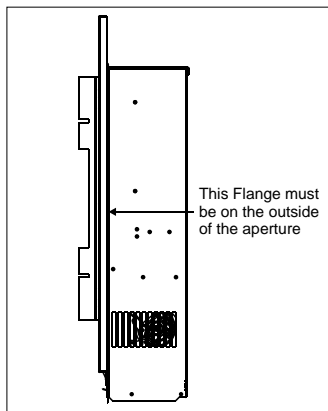

19. Pebble effect setup:

Remove the pebbles carefully from the packaging and place the pebbles evenly on the effect tray. The fire is supplied with a pebble effect light box that is positioned on top of the flame effect panel as shown in the diagram (right).

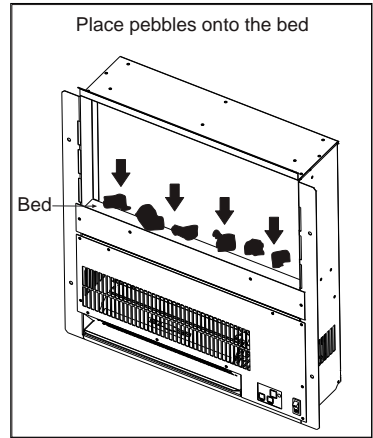

20. Moulded Log effect setup:

Fit as shown in the diagram (right). In this case the pebble effect light box is not used.

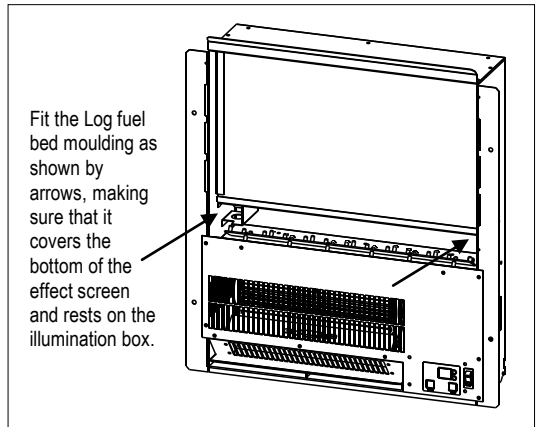

21. Fit the Facia *see below*:

**FITTING THE FASCIA:**

The fire front may now be fitted to the fire chassis as follows.

At the rear of the facia frame there is a large v shaped hook. Hook this over the fixing lip located on the fire back.

Carefully lower the bottom edge of the facia frame towards the fire chassis until the magnets connect the facia frame to the fire chassis.

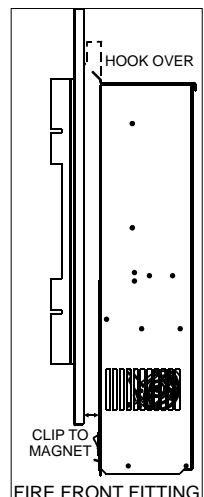

## SECTION 2: OPERATING YOUR FIRE

### OPERATING THE FIRE IN MANUAL MODE (Not applicable to LE Timer fires)

MANUAL MODE IS USED IF THE OPTIONAL REMOTE HANDSET HAS NOT BEEN PURCHASED, HAS BEEN MISLAID OR THE BATTERIES ARE FLAT.

**To operate the fire in manual mode follow the steps below:**

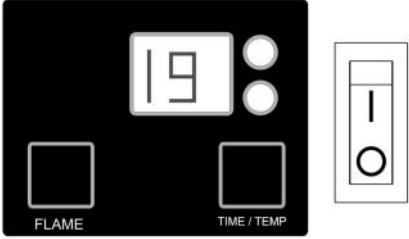

**1**

SWITCH ON  
PRESS |



**2**

PRESS  
**'FLAME'**

NOTE: BY PRESSING 'FLAME' MORE THAN ONCE  
THERE ARE THREE INTENSITY SETTINGS AVAILABLE

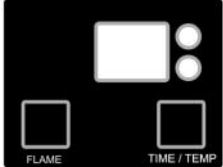

**3**

PRESS  
"TIME/TEMP" FOR HEAT  
PRESS UNTIL THE DESIRED  
TEMPERATURE IS SHOWN  
ON THE DISPLAY.

NOTE: THE SET TEMPERATURE RANGE IS FROM  
18 to 28, IF 28 IS EXCEEDED BY ONE CLICK THE  
FIRE WILL BE PERMANENTLY ON DISPLAYED 'ON';  
A FURTHER CLICK WILL RESET THE SETTING  
BACK TO 18.

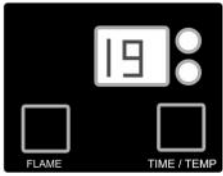

NOTE:  
THE DISPLAY INDICATES THE TEMPERATURE OF THE  
SENSOR WHICH IS LOCATED INSIDE THE FIRE, AS A  
RESULT THE ACTUAL ROOM TEMPERATURE WILL BE  
LOWER THAN INDICATED, WE SUGGEST THAT THE  
TEMPERATURE IS GRADUALLY RAISED UNTIL A  
COMFORT LEVEL IS ACHIEVED.

# OPERATING YOUR FIRE—REMOTE OPTION FIRE

## REMOTE OPERATION:

(Not applicable to LE Timer fires or if the remote option has not been purchased)

On first use insert the batteries into the remote control handset—see battery replacement section below. With the mains supply connected to the fire and switched on the fire can be operated.

## CARE

DO NOT drop - DO NOT immerse in liquids - DO NOT leave flat batteries in the unit -Clean only with a dry cloth.

As this product operates using infra-red, ensure there is a clear line of sight between the handset and the appliance for it to operate effectively.





## REMOTE HANDSET BATTERY REPLACEMENT:

To replace the batteries in the remote handset remove the battery compartment cover and remove the batteries. Replace the batteries with either rechargeable or non-rechargeable batteries of type: AAA, MN2400, LR23, or UM4.

**DO NOT MIX** Rechargeable and Non rechargeable batteries.



## **To operate your fire in Remote mode follow the steps below:**

- 1) When the Mains supply has been turned on the Fire can be activated to Standby mode by pressing  the switch on the Fire as shown.
- 2) To switch the Fire on press  on the remote handset; Now the Flame effect and Fuel bed will be on.
- 3) Press 'Flame intensity -'; Flame effect and Fuel bed become dimmer (there are 4 steps).
- 4) Press 'Flame intensity +'; Flame effect and Fuel bed become brighter (there are 4 steps).
- 5) Press 'DISPLAY ON/OFF' Control, the Flame effect and Fuel bed switch on/off.
- 6) Press 'HEATER ON/OFF'; The Heater will come on if the set temperature is greater than the temperature of the environment.
- 7) Press 'Temp +'; the set temperature will raise 1°C per press (after 28 the Fire will be permanently on, a further press will reset to the minimum temperature).
- 8) Press 'Temp -'; the set temperature will lower 1°C per press.
- 9) Press 'HEATER ON/  OFF' again; the Heater will switch off.
- 10) At any stage if you press  the Fire will go off.
- 11) The Fire can be operated with Flame effect and Fuel bed with or without the Heater on.

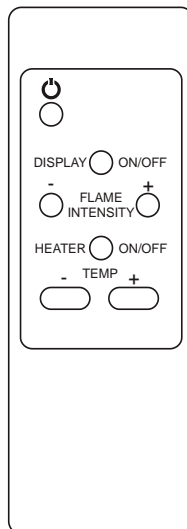
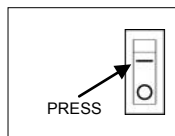





# OPERATING YOUR FIRE—LE TIMER FIRE

(Not applicable to Manual / remote fires)

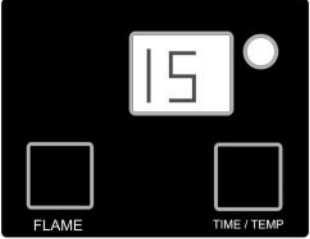
To operate the fire follow the steps below:

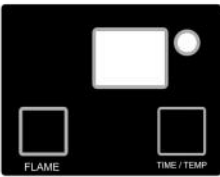
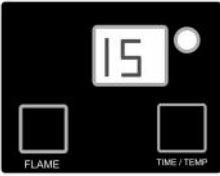
	
<p><b>1</b> SWITCH ON PRESS  </p>	
<p><b>2</b> PRESS 'FLAME'</p> <p>NOTE: BY PRESSING 'FLAME' MORE THAN ONCE THERE ARE THREE INTENSITY SETTINGS AVAILABLE</p>	
<p><b>3</b> PRESS "TIME/TEMP" FOR HEAT PRESS ONCE FOR 15 mins (15) TWICE FOR 30 mins (30) THREE TIMES FOR 1 Hr (1H) FOUR TIMES FOR 2 Hrs (2H) REPEAT IF REQUIRED TO SET OPERATION TIME</p>	

## **SECTION 3: MAINTENANCE AND CLEANING**

### **DISCONNECT THE FIRE FROM THE SUPPLY BEFORE CLEANING OR CARRYING OUT ANY MAINTENANCE CLEANING**

*Warning: If the air inlet becomes covered with dust the fire may cut out. This is a safety feature. Refer to Safety Cut-out information for further action.*

### **IMPORTANT NOTICE**

Your electric fire operates using a rotary fan. Due to the working nature of this fan it is inevitable that a build-up of LINT, or general house dust (i.e.) carpet fibres or animal fur etc. will from time to time accumulate around the inlet and outlet grills. Therefore it is recommended that regular cleaning of this area is undertaken using a standard vacuum cleaner attachment.

For safety reasons please ensure that the fire is switched off and has had time to cool down before cleaning.

#### **GENERAL CLEANING:**

The fire should be cleaned with an antistatic cloth to prevent dust being attracted to the high gloss surfaces of the fire - do not use polish! For difficult to remove marks such as finger marks it is recommended that a chamois leather slightly damp is used.

Care should be taken when cleaning around metal parts; non-painted metal parts may have sharp edges.

#### **DO NOT USE ABRASIVE MATERIALS**

##### **Decorative parts:**

**Under no circumstances use an abrasive cleaner on bright surfaces. Such use will cause permanent damage to the appearance of your fire.**

It is important to use care in cleaning. Dusting or wiping with a damp cloth is recommended in order to preserve the finish.

##### **Fuel Bed:**

Clean with a vacuum cleaner attachment or a soft brush.

##### **Light and Flame Effects:**

No maintenance should be necessary on the light / flame effect, illumination is by LED's which should not require any attention for the life of the fire except for damage to the LED's or failure of the LED power supply — in which case the fire must be returned to Imperial fires for replacement of the damaged / faulty part(s).

## SECTION 4: IMPORTANT INFORMATION

### SAFETY CUT-OUT:

The heating element is fitted with a cut-out which will switch off the fire in the event the fire overheats, should this occur follow the points below.

Switch the fire off at the wall outlet, the fire must be isolated from the mains power supply.

Ensure that there are no obstructions in or around the air inlet or air outlets.

After approximately 5 minutes the fire can be switched back on.

### WARNING

Do not switch the fire on until the above checks have been completed.

If the fault is persistent contact your retailer or Imperial Fires Customer Service on the telephone numbers provided at the beginning of these instructions.

<b>TECHNICAL SPECIFICATION</b>	
Voltage	220 ~240v A.C.
Power Input	1532w
<b>MAINS CORD:</b> Mains Cord UK Plug	If the mains supply cord is damaged it must be replaced by a competent electrician or similarly qualified person

<b>FEATURES—MANUAL / REMOTE FIRE</b>			
KEY	Standard	Option	Not available
Heat output	1.5kW		
Timer operation			
Living flame effect			
Thermostat			
Digital display			
Remote control			
Manual control			

<b>FEATURES—LE TIMER FIRE</b>			
KEY	Standard	Option	Not available
Heat output	1.5kW		
Timer operation	15mins—30mins—1Hr—2Hr		
Living flame effect			
Thermostat			
Digital display			
Remote control			
Manual control			

## SECTION 4: IMPORTANT INFORMATION Continued

<b>Dimensional Specifications (GL Wide / GL Standard)</b>	
Height	590mm / 575mm
Width	720mm / 580mm
Depth	165mm / 165mm
Minimum mounting height from floor or surface	60mm
Minimum aperture size	535mm High x 440mm Wide

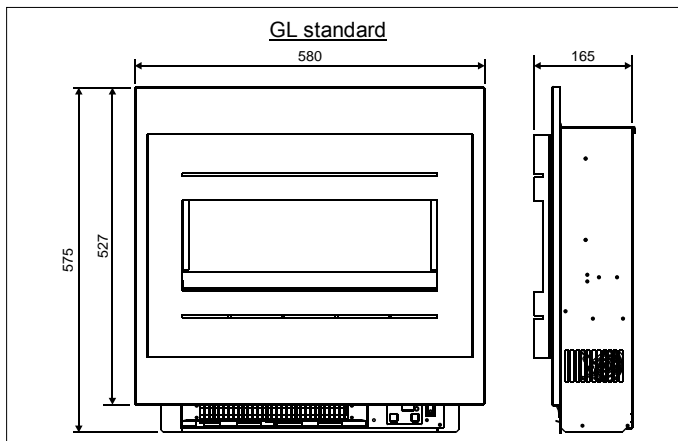
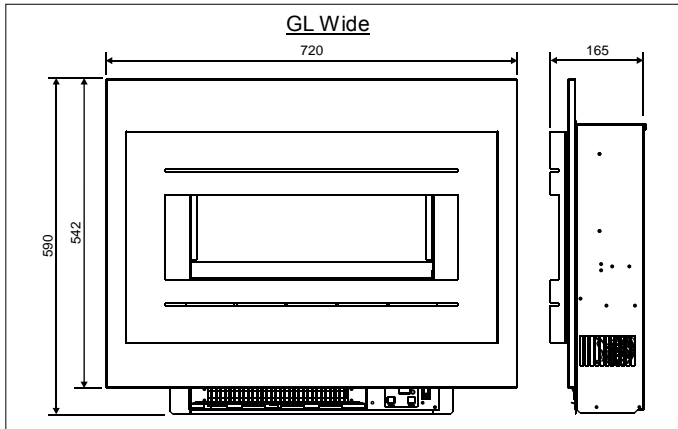

## **NOTES**

# **NOTES**

## **GUARANTEE**

This product is guaranteed against faulty parts or workmanship for 12 months from the date of purchase.

To validate the guarantee the product must be returned to the retailer or supplier for repair or replacement with this sheet completed with the detail requested. (Please do not send a photocopy).

Imperial Fires Limited are not responsible for any cost incurred by the customer in returning the product to the seller.

**When making a claim under warranty you must provide the details requested below otherwise your warranty might be invalid.**

**Return this form to your dealer or contact Imperial Fires Limited.**

**Imperial Fires Limited reserves the right to refuse warranty for any product returned that does not have valid proof of date of purchase:**

**Please return your original sales invoice with any returned product.**

This guarantee does not affect your statutory rights.

Insert Your Full Name

Insert Your Full Address

Post Code

Daytime Contact Telephone Number

Affix Data Label

Return this form to

Widney Leisure Ltd

St Marys Road

Nuneaton

Warwickshire

CV11 5AU

Telephone +44(0) 2476 377550

Email: [sales@widney-leisure.co.uk](mailto:sales@widney-leisure.co.uk)

