



EC328 Power Control System

1 Key Features

- Battery Charger / Power Supply – Incorporates an air cooled 300 Watt multi-stage power converter unit that charges the batteries and provides 12V DC power.
- Built-in dual Solar Regulator - Allows the direct connection of a 20 to 120W solar panel without the need for additional components. The dual regulator charges both the vehicle and leisure batteries simultaneously.
- Enhanced Digital Control Panel - With scrolling menu system, battery condition (voltage and current), water tank levels, tank and battery level warnings with battery protect circuit, alarm clock and programmable event timer.

2 System Overview

The following diagram shows the typical configuration of the EC328 system. The key component is the EC328 power supply unit (PSU), which is the hub of the system and provides connectivity to the ancillary components and the EC328 digital control panel.

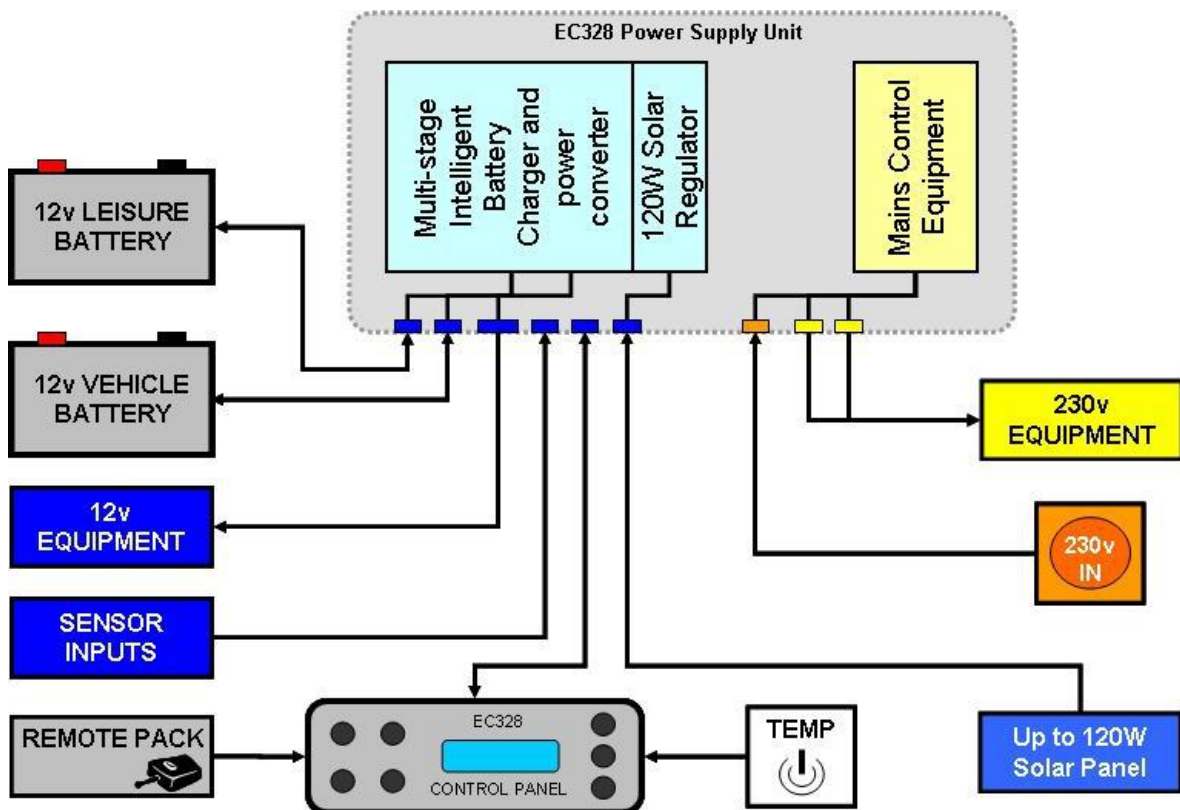



EC328 Power Control System

3 Power Supply Details

For the safe operation of all electrical equipment within your Leisure Vehicle it is important that you read and fully understand these instructions. If you are unsure of any point please contact your dealer/distributor for advice before use.

The following diagram shows the EC328PSU layout.

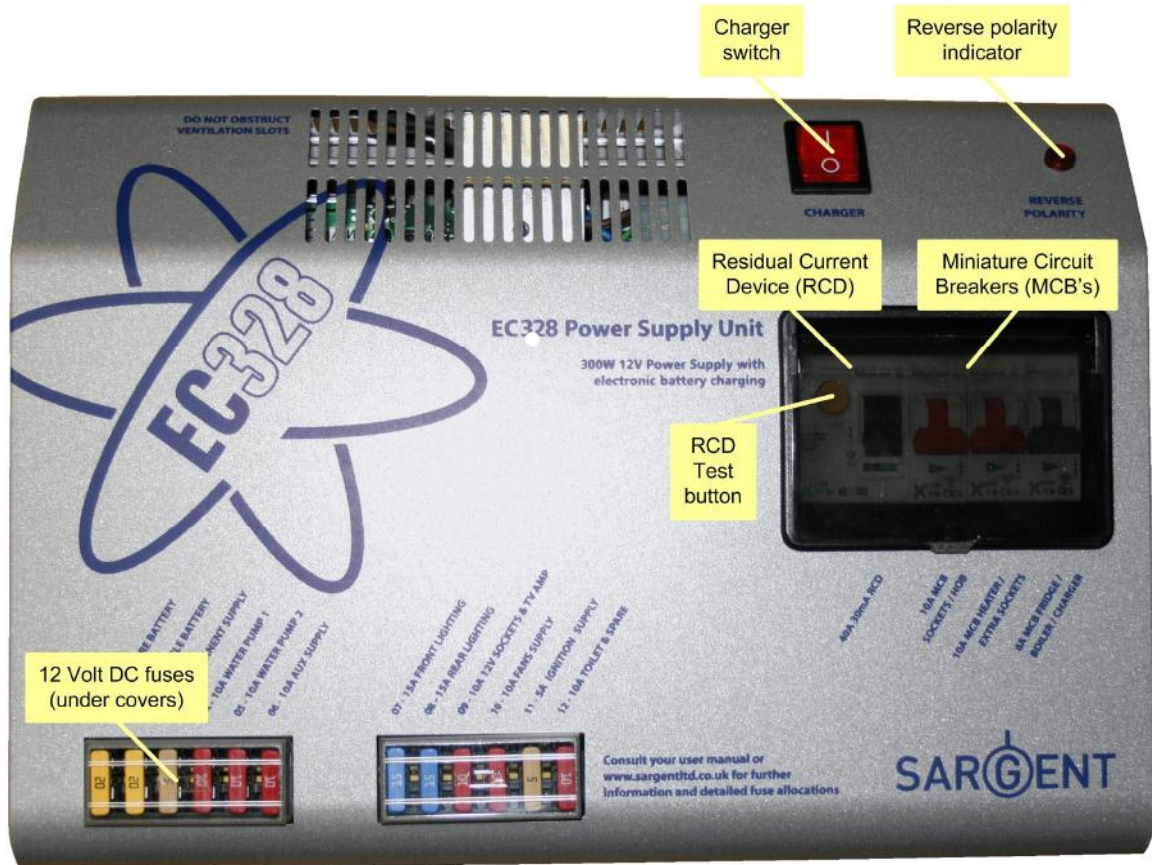

WARNING

Under heavy loads the EC328PSU case may become hot. ALWAYS ensure the ventilation slots have a clear flow of air. Do not place combustible materials against / adjacent to the EC328PSU. The PSU will shutdown if overheated and will restart automatically when cool.

3.1 Residual Current Device & Miniature Circuit Breakers

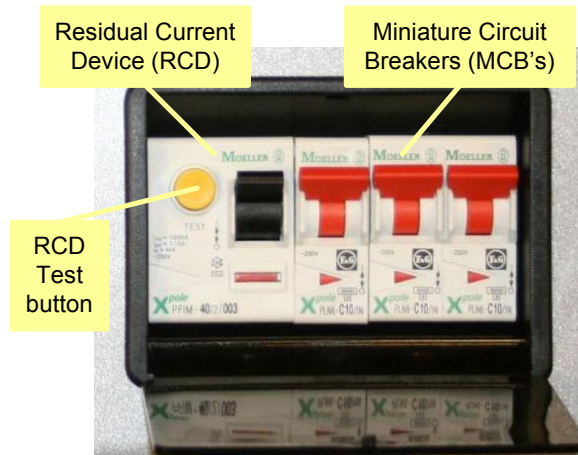

The Residual Current Device (RCD) is basically provided to protect the user from lethal electric shock. The RCD will turn off (trip) if the current flowing in the live conductor does not fully return down the neutral conductor, i.e. some current is passing through a person down to earth or through a faulty appliance.

To ensure the RCD is working correctly, the test button should be operated each time the vehicle is connected to the mains supply (see section 5.1)

The Miniature Circuit Breakers (MCB's) operate in a similar way to traditional fuses and are provided to protect the wiring installation from overload or short circuit. If an overload occurs the MCB will switch off the supply. If this occurs you should investigate the cause of the fault before switching the MCB back on.



EC328 Power Control System

The following table shows the rating and circuit allocation for the three MCB's

MCB	Rating	Wire Colour	Description
1	10 Amps	White	230v Sockets
2	10 Amps	White (Yellow for heater)	Extra 230v Sockets / Heater
3	6 Amps	Black (Blue for water heater)	Fridge / Water Heater / 12v Charger (internally connected)

3.2 Battery Charger

The EC328 system incorporates an intelligent three-stage battery charger / power converter.

During stage 1 the battery voltage is increased gradually while the current is limited to start the charging process and protect the battery. At stage 2 the voltage rises to 14.4V to deliver the bulk charge to the battery. When the battery is charged, the voltage is decreased at stage 3 to 13.6V to deliver a float charge to maintain the battery in the fully charged state. The charger can be left switched on continuously as required.

The battery charger / power converter also provides power to the leisure equipment when the mains supply is connected. This module supplies DC to the leisure equipment up to a maximum of 25 Amps (300 Watts), therefore the available power is distributed between the leisure load and the battery, with the leisure load taking priority as per the following example:

Leisure load	Available power for battery charging
5A	20A
10A	15A
15A	10A
20A	5A

3.3 Solar Panel Converter

The EC328PSU incorporates a built-in dual channel Solar Regulator that allows the direct connection of a 20 to 120W solar panel without the need for additional components. The dual regulator charges both the vehicle and leisure batteries simultaneously and connects to the PSU via a dedicated connector on the base of the unit (see section 6.5 for connector details).

A connection harness is available from your dealer or the Sargent web site.

3.4 Fuses

WARNING

When replacing fuses always replace a fuse with the correct value. NEVER replace with a higher value / rating as this could damage the wiring harness. If a replacement fuse 'blows' do not keep replacing the fuse as you could damage the wiring harness. Please investigate the fault and contact your dealer.

The following table shows the fuse allocation for the 12 fuses fitted to the EC328PSU.

Fuse	Rating	Fuse Colour	Wire Colour	Description
1	20 Amps	Yellow	Brown / Blue	Leisure Battery
2	20 Amps	Yellow	Brown / Green	Vehicle Battery
3	5 Amps	Tan	Brown / Yellow	Permanent Supply (Radio / Fridge)
4	10 Amps	Red	Green / Blue	Water Pump 1
5	10 Amps	Red	Green / White	Water Pump 2
6	10 Amps	Red	Grey / Red	Auxiliary Supply (Awning / Entry Light)
7	15 Amps	Blue	Grey	Front Lights



EC328 Power Control System

8	15 Amps	Blue	Pink	Rear Lights
9	10 Amps	Red	Yellow / White	12v Sockets / TV Amplifier / Entertainment
10	10 Amps	Red	Black / tracer	Fans / Heater Fans
11	5 Amps	Tan	Yellow / Green	Ignitions Supply (Heaters / Cooker)
12	10 Amps	Red	Purple	Toilet Pump

The following table shows details of the fuse(s) located at the Leisure battery.

Battery 1	20 Amps	Yellow	Brown / Blue	Fuse remotely located near battery
Battery 2	20 Amps	Yellow	Brown / Blue	Fuse remotely located near battery 2 (where fitted)

3.5 Battery

A) Type / Selection

For optimum performance and safety it is essential that only a proprietary brand LEISURE battery is used with a typical capacity of 75 to 120 Ah (Ampere / hours). A normal car battery is NOT suitable. This battery should always be connected when the system is in use.

The PSU is configured to work with standard lead acid leisure batteries, and in most cases is also compatible with the latest range of Absorbed Glass Matt (AGM) batteries. Before fitting non-standard batteries please check that the charging profile described in 3.2 is suitable for the type of battery by referring to the battery documentation or battery manufacturer.

Some vehicle installations can cater for two leisure batteries connected in parallel. In these cases it is recommended that two identical batteries are used.

The battery feed is fitted with an inline fuse between the battery and the electrical harness, and is usually located immediately outside the battery compartment or within 500mm of the battery. The maximum rating of this fuse is 20A per battery. If two or more batteries are fitted the maximum total fusing value must not exceed 40A.

B) Installation & Removal

Always disconnect the 230v mains supply and turn the EC328PSU charger switch to the OFF (0) position before removing or installing the battery.

When connecting the battery, ensure that the correct polarity is observed (black is negative [-] and red is positive [+]) and that the terminals are securely fastened. Crocodile clips must not be used.

WARNING

Explosive gases may be present at the battery. Take care to prevent flames and sparks in the vicinity of the battery and do not smoke.

C) Operation / Servicing

Under normal circumstances it should not be necessary to remove the battery other than for routine inspection of the terminals and "topping up" of the battery fluid where applicable. Please see instructions supplied with the battery.

Note: Do not over discharge the battery. One of the most common causes of battery failure is when the battery is discharged below the recommended level of approximately 10v. Discharging a battery below this figure can cause permanent damage to one or more of the cells within the battery.

To prevent over discharge, the EC328 system incorporates a battery protect circuit that warns and then disconnects the batteries when they fall below the following conditions:



EC328 Power Control System

Battery	Voltage cut off	Action after cut off	Notes
Vehicle	10.9v	Battery selection is changed from Vehicle battery to Leisure battery. If the leisure battery is below 9v then a further warning will occur (see below).	This cut off level is designed to protect the vehicle battery from over discharge. The 10.9v level ensures there is sufficient power in the battery to run the vehicle electronics and start the vehicle. This cut off only applies to power drawn from the battery by the leisure equipment; it will not protect the battery if you leave the vehicle lights on.
Leisure	9v	Power is turned off	This is an emergency cut off level to protect the battery from severe damage. You should not rely on this cut off level during normal operation, but manage your power consumption to a discharge level of 10v. This cut off only applies to power drawn from the battery by the leisure equipment that is controlled by the control panel power switch; it will not protect the battery from discharge by the radio or other permanently connected equipment.

4 Control Panel Details

4.1 Layout and Buttons

The following diagram shows the control panel layout and button functions.

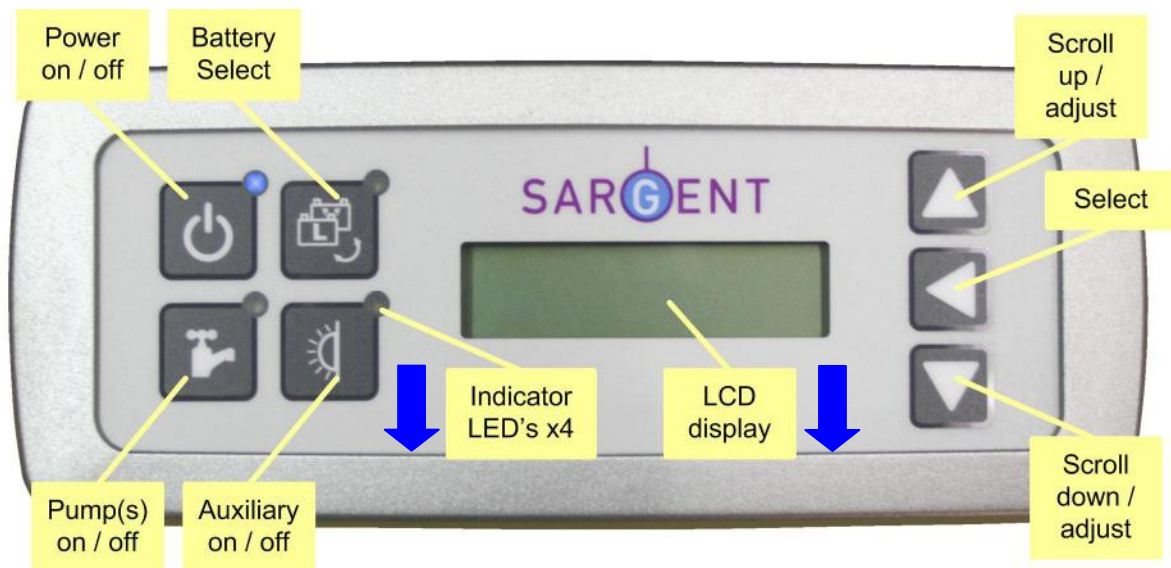

Note: to remove the decorative bezel, **pull down** and **lift forward** as indicated by the **blue** arrows.

Item	Function	Options / Notes
Power ON / OFF	Use to turn the main leisure power on and off.	The adjacent LED is illuminated when the power is ON.



EC328 Power Control System

Item	Function	Options / Notes
Battery SELECT	Use to select the Leisure or Vehicle battery. Press the button to toggle between the leisure and vehicle batteries. When a battery is selected this battery will be used as the power source and will also be charged by the charger.	The adjacent LED is illuminated when the VEHICLE battery is selected; by default when the power is initially turned on the Leisure battery is selected and is indicated by the battery select LED off.
Pump ON/ OFF	Use to turn the water pump(s) power on and off (see section 4.3)	The adjacent LED is illuminated when the pump power is ON.
Aux ON / OFF	Use to turn the Auxiliary power on and off (see manufacturers handbook for detail of what items are operated by the auxiliary function).	The adjacent LED is illuminated when the auxiliary power is ON.
Scroll UP ▲	Use to scroll the display up (settings section of the menu) or adjust the selected setting (see section 4.3)	Note: the menu screens operate in a continuous loop, therefore you can use either the UP or DOWN buttons to move to any screen
Scroll DOWN ▼	Use to scroll the display down (readings section of the menu) or adjust the selected setting (see section 4.2)	
Select ◀	Use to select a menu item within the settings section (see section 4.2 & 4.3)	Use to move to the next setting, when entering alarm / event times

Note: the display backlight operated for approximately 6 seconds after any key press.

4.2 Menu Functions - Readings section

	Display	Description	Options / Notes
	<div style="border: 1px solid black; padding: 5px; text-align: center;"> EC328 v2.1H 12:00 23.9°C </div>	Main Control Panel display showing model number (EC328), software version number (v2.1), specification (H), current time (12:00) and Internal temperature (23.9°C) in centigrade	<p>The addition of a asterisk (*) in the top left of the display indicates that the alarm is set</p> <p>The addition of a hash (#) in the top right of the display indicates that the event timer is set</p> <p>The addition of the letters 'AC' in the centre of the display indicates that the AC Mains supply is switched on</p>
▼	<div style="border: 1px solid black; padding: 5px; text-align: center;"> Leisure Battery 12.5v (Good) </div>	Voltage reading and battery condition description for the on-board leisure battery See also 3.5C	Less than 10.9 = (Poor) 10.9 to 11.8 = (Fair) 11.9 to 14.4 = (Good)
▼	<div style="border: 1px solid black; padding: 5px; text-align: center;"> Vehicle Battery 13.3v (Good) </div>	Voltage reading and battery condition description for the vehicle battery See also 3.5C	Less than 10.9 = (Poor) 10.9 to 11.8 = (Fair) 11.9 to 14.4 = (Good)
▼	<div style="border: 1px solid black; padding: 5px; text-align: center;"> Mains Supply ON </div>	Indication of the 230v mains supply.	ON = mains supply on OFF = mains supply off



EC328 Power Control System

▼	Fresh Water 25% Full	<p>Water level in the fresh water tank (5 measurement levels)</p> <p>If the water pump power switch is turned ON and the water level drops below 25% a warning beep will be heard and the LCD display will flash. To cancel the warning, press the select (◀) button. The warning will not be repeated unless the water pump power switch is turned off and on again. This is to ensure the warning does not become a nuisance.</p>	<p>0% < ¼ Full (Nearly empty)</p> <p>25% >= ¼ Full</p> <p>50% >= ½ Full</p> <p>75% >= ¾ Full</p> <p>100% = Full</p>
▼	Waste Water 0% Full	<p>Water level in the waste water tank (2 measurement levels)</p> <p>If the water pump power switch is turned ON and the waste water level rises to 100% a warning beep will be heard and the LCD display will flash. To cancel the warning, press the select (◀) button. The warning will not be repeated unless the water pump power switch is turned off and on again. This is to ensure the warning does not become a nuisance.</p>	<p>0% < ½ Full</p> <p>50% >= ½ Full (optional level that is not normally fitted by most manufacturers)</p> <p>100% = Full</p>
▼	External Temp 26.5°C	<p>External temperature (in degrees centigrade) as measured by the external temperature probe</p>	
▼	Battery Current 5.4 Amps	<p>Current (in Amps) being drawn from or charged into the selected battery*</p> <p>If a solar panel is fitted this display will include the current being provided by the solar panel.</p>	<p>Negative figure (-) = current being drawn from the selected battery</p> <p>Positive figure = current being used to charge the selected battery</p>

* Inaccuracies to the current reading can occur if the control panel has been replaced or batteries are removed from the installation and charged using a separate charger. To re-calibrate the system, initially ensure the Charger is turned off at the PSU and the 12V Power is off at the Control Panel.

Then from the "Battery Current" screen press and hold the select (◀) button, "Calibrating" will appear on screen, keep the button held until the current value is displayed and Release the Select button.



EC328 Power Control System

4.3 Menu Functions - Settings section

Display	Description	Options / Notes
▼ Pump Select? <Internal>	Shows the currently selected pump that will be operated by pressing the pump on / off switch (TAP symbol) Use the select button (◀) to change Note: if your water pump stops working, this setting may have been inadvertently changed.	<INTERNAL> = The internal pump will be operated by the pump switch <EXTERNAL> = The External pump will be operated by the pump switch <BOTH> = Both the Internal and External pumps will be operated simultaneously by the pump switch
▼ Water Tank Fill? <Start 1 Min>	Allows operation of the External pump for a period of one minute (for filling the internal tank from the external tank) Use the select button (◀) to START (or STOP)	Will have no effect if the External pump is already switched on (see above) Will not operate if the Internal (Fresh) water tank is showing 100% Full
▼ Clock Set? 12:00	Access to set the internal clock Press the select button (◀) to select HOUR Use the up / down (▲▼) buttons to change Press the select button (◀) to select MINUTE Use the up / down (▲▼) buttons to change Press the select button (◀) to exit	Please note the clock uses a 24 hour cycle
▼ Alarm Set? 12:00	Access to set the alarm clock Press the select button (◀) to select HOUR Use the up / down (▲▼) buttons to change Press the select button (◀) to select MINUTE Use the up / down (▲▼) buttons to change Press the select button (◀) to exit	Please note the alarm uses a 24 hour cycle
▼ Alarm = Off	Shows the alarm clock status (on / off) Press the select button (◀) to switch between OFF or ON	The addition of an asterisk (*) in the top left of the main EC325 display indicates that the alarm is set



EC328 Power Control System

	Display	Description	Options / Notes
▼	Set Event Timer?	<p>Access to set the event timer Press the select button (◀) to select HOUR ON</p> <p>Use the up / down (▲▼) buttons to change</p> <p>Press the select button (◀) to select MINUTE ON</p> <p>Use the up / down (▲▼) buttons to change</p> <p>Press the select button (◀) to select HOUR OFF</p> <p>Use the up / down (▲▼) buttons to change</p> <p>Press the select button (◀) to select MINUTE OFF</p> <p>Use the up / down (▲▼) buttons to change</p> <p>Press the select button (◀) to exit</p>	<p>Please note the event timer uses a 24 hour cycle</p> <p>The event timer is used to switch the control panel power on and off in the absence of the user / occupier.</p> <p>See section 4.4 for further details.</p>
▼	Event Timer =Off 12:00 till 12:00	<p>Shows the event timer status (OFF / ON) and the current On and Off times</p> <p>Press the select button (◀) to switch between OFF or ON</p>	<p>The addition of a hash (#) in the top right of the main EC325 display indicates that the event timer is set</p>

4.4 Event Timer example

The event timer is designed to allow the leisure vehicle user to turn the 12v power on or off (in the same way as using the control panel power button) without being in the vehicle. This allows lights or other equipment to be turned on or off at a predetermined time.

Example - to turn on one interior light at 11.00pm for 1 hour

Ensure the clock is set to the correct time

Scroll to the 'Set Event Timer?' screen

Following the instruction in section 4.3, set the ON time to 23:00 and the OFF time to 24:00

Scroll to the 'Event Timer=' screen and select ON

Scroll to the main control panel display and ensure a hash (#) is displayed in the right of the display

Turn all lights and 12v equipment off in the vehicle except the light that you want the event timer to automatically switch on

Turn the 12v power off on the control panel

Exit the vehicle

At 11:00pm (23:00) the control panel will switch the 12v power on and therefore any equipment that was left switched on will be turned on. The 12v power will be switched off at Midnight (24:00).



EC328 Power Control System

4.5 Warning Messages

Vehicle Battery Dangerously Low	This WARNING display indicates that the Vehicle battery voltage is low (10.9 volts or less). The panel will beep for one minute and then switch over to the Leisure battery to prevent draining the Vehicle battery.	You can switch over to the Leisure battery immediately (and cancel the beep) by using the battery selector switch
Leisure Battery Dangerously Low	This WARNING display indicates that the Leisure battery voltage is low (9 volts or less). The panel will beep for one minute and then switch the power off to prevent damage to the leisure battery.	See section 3.5 for further details
System disabled Engine started	This WARNING display indicates that the system has been disabled because the vehicle engine is running	EMC (Electro Magnetic Compatibility) directive 89/336/EEC requires that electrical accessories within the vehicle are disconnected while the vehicle is in motion

5 Operational & Safety Information

5.1 Connecting to the Mains supply - Safety checks

For your safety it is **IMPORTANT** that you follow these connections instructions each time your Leisure Vehicle is connected to a mains supply.

- A) **Ensure suitability of the Mains Supply.** Your Leisure Vehicle should only be connected to an approved supply that meets the requirements of BS7671. In most cases the site warden will hold information regarding suitability of supply. If using a generator you also need to comply with the requirements / instructions supplied with the generator. Please note that some electronic generators may not be compatible with your leisure system.
- B) **Switch the EC328PSU internal Power Converter OFF.** Locate the charger power switch on the EC328PSU and ensure the switch is in the OFF (0) position before connection to the mains supply.
- C) **Connect the Hook-up Lead.** Firstly connect the supplied hook-up lead (orange cable with blue connectors) to the Leisure Vehicle and then connect to the mains supply.
- D) **Check Residual Current Device operation.** Locate the RCD within the EC328PSU and ensure the RCD is switched on (lever in up position). Press the 'TEST' button and confirm that the RCD turns off (lever in down position). Switch the RCD back to the on position (lever in up position). If the test button failed to operate the RCD see section 5.2.
- E) **Check correct Polarity.** Locate the 'Reverse Polarity' indicator on the EC328PSU and ensure that the indicator is NOT illuminated. If the indicator is illuminated see section 5.2.
- F) **Check Miniature Circuit Breakers.** Locate the MCB's within the EC328PSU (adjacent to the RCD) and ensure they are all in the ON (up) position. If any MCB's fail to latch in the on position see section 5.2.
- G) **Turn the EC328PSU ON.** Locate the charger power switch on the EC328PSU and turn to the ON (I) position. The switch will illuminate when turned on.
- H) **Check operation of equipment.** It is now safe to check the operation of the 12v and 230v equipment.



EC328 Power Control System

5.2 Common Fault Table

Fault	Possible Cause	Proposed Fix
No 230 volt output from PSU	Connecting lead between the site and Leisure Vehicle not connected	Check and connect lead as per 5.1C Check also input connector at the base of the EC328PSU
	RCD switched off	Reset RCD as per 5.1D
	RCD not operating correctly	Check supply polarity; if the RCD continues to fail contact your Dealer, as there is probably an equipment or wiring fault.
	MCB switched off	Reset MCB by switching OFF (down position) then back ON (up position), if the MCB continues to fail contact your Dealer, as there is probably an equipment or wiring fault.
	No or deficient supply from site	Contact site Warden for assistance
	Other fault	Contact your Dealer
Reverse Polarity light is illuminated on PSU	Mains Supply reversed?	The reverse polarity light is designed to illuminate when the Live and Neutral supply has been reversed / crossed over. If the light illuminates there is a problem with the site supply or the cable connecting the supply to your vehicle. The light is designed to work on UK electrical supplies (where the neutral conductor is connected to earth at the sub station). If you are using your vehicle outside the UK this light may illuminate when no fault exists. In these cases consult the site warden for advice.
	Generator being used	The Reverse Polarity warning light is on when using my Generator. This is a normal side effect when using some types of generator. Instead of connecting the neutral conductor to earth, some generators centre tap the earth connection making both neutral and live conductors 110v above earth. This 110v difference causes the neon polarity indicator to illuminate. In most cases it is still safe to use the generator, but please consult the generator handbook for further information.
Control Panel Problems	Control Panel has no display	Check batteries, turn EC328PSU charger switch on, and ensure mains supply is connected. Check control panel connecting lead at EC328PSU and behind Control Panel Contact your Dealer
	12v Power turns off	Battery save feature has operated to protect the Vehicle battery and or the Leisure battery. See 3.5C Engine has been started, all equipment has been disconnected to meet EMC requirements. See 4.4
	Control Panel display corrupt / erratic function	Observe control panel handling instructions Control panel software may have crashed. Reboot control panel by turning off the EC328PSU charger switch and removing fuses 1 & 2 at the EC328PSU (2x20A fuses for leisure and vehicle batteries). Wait 30 seconds then replace the fuses and turn the charger switch on. (Alternatively, remove the bezel at the control panel by pulling down in the centre at the bottom, unplug the control panel multi-way connector, wait 30 seconds, then plug back in and reassemble.
	Control Panel contrast poor	Observe control panel handling instructions Remove control panel as above but do not unplug. Carefully adjust contrast preset (small adjuster) on back of control panel using jewellers screwdriver
	Control Panel current reading incorrect	Re-calibrate the current sensor as follows: With the charger switch turned off, and the power turned off at the control panel (no LED's on) Scroll down ▼ the display until battery current is shown Hold down the select button ◀ (left arrow) until 'calibrating....' appears; keep the button pressed until the battery current reading reappears. Release the button. The current reading should now be correct



EC328 Power Control System

Fault	Possible Cause	Proposed Fix
No 12 volt output from PSU	No 230v supply	Check all above
	Charger not switched on	Switch charger switch on (I) position, switch will illuminate
	Battery not connected and / or charged	Install charged battery as per 3.5
	Power switch on control panel not switched to ON	Turn power on at control panel
	Battery flat / Battery fuse blown	Recharge battery, check fuses, check charging voltage is present at battery
	Fuse blown	Check all fuses are intact and the correct value fuse is installed as per fuse table
	Equipment switched off / unplugged	Check equipment is switched on and connected to the 12v supply
	PSU overheated / auto shutdown operated	Reduce load on system. Allow PSU to cool down. PSU will automatically restart when cool. See 3.2
	Other fault	Contact your Dealer
Pump not working	Fuse blown	Replace fuse
	Pump turned off	Turn pump on by pressing the pump button at the EC328 control panel (tap symbol)
	Setting incorrect	Both the internal and external pump feeds are controlled from the EC328 control panel. To alter the setting of the pump switch (tap button) see section 4.3 Ensure the setting matches your desired requirement.



EC328 Power Control System

6 Technical Data & Approvals

6.1 Outline Specification

INPUT 230v	230 Volts / 0 to 16 Amps	+ / - 10%
OUTPUT 230v	RCD protected, 3 x MCB outputs of 10, 10 and 6A via 2 x 9 way connectors	
INPUT 12v	2 x 20A battery inputs via a single 6 way connector	
SOLAR INPUT	1 x Dedicated solar panel input (20 to 120W panel) via a 4 way connector	
OUTPUT 12v	25A total output via 4 x 16A switched channels protected by 12 fused outputs via a 15 way connector	
Integrated CHARGER	Input 220-240 Volts AC +/- 10%, Frequency 50 Hz +/- 6%, Current 3A max. DC Output 13.6 to 14.4 Volts nominal, Current 25 Amps max (300 Watts).	
Signal INPUT	4 x Fresh water level, 2 x Waste water level, 1 x Engine running, 2 x battery temp sensor via a 10 way connector	Fresh water negative sensed Waste water negative sensed
Data IN / OUT	Data communication and power to Control Panel via 20 way IDC header connector	
IP rating	IP31	
Operating temperature	Ambient 0 to 35° Centigrade PSU case temperature with full load 65° C Max	Automatic shutdown and restart if overheated / overloaded

6.2 Dimensions

EC328PSU	Overall size (HxWxD) 240 x 370 x 110mm	Fixing centres 210 x 360mm
	Clearances 75mm above, 20mm below, 50mm left & right	Weight 3.8 Kg
EC328 CONTROL PANEL	Overall size (HxWxD) 80 x 193 x 40mm	Fixing centres 175mm
	Cut-out size (HxW) 60 x 165mm	Weight 170 g

6.3 Approvals

System: BSEN 1648-1, BSEN1648-2 compliant, BS7671: 2001 compliant

Residual Current Device: RCD 40A 30mA trip to BS EN 61008

Miniature Circuit Breakers: MCB's (10 & 6A) type C 6000A breaking capacity to BSEN 60898

Electro Magnetic Compatibility (EMC) directive 2004/108/EC Certificate CE20071224-1

Integrated Charger: BS EN 60335-1/2.29, 2006/95EC, IEC61000-3.2/3:1995, 1.

Low Voltage Directive: 2006/95EC TUV-014900-A1, EN55022, Class B, EN55024/ Level 2

6.4 Declaration of Conformity

Equipment: Leisure Power Control System

Model name: EC328PSU / EC328CP / -STD / -DLX

I hereby declare that the equipment named above has been designed to comply with the relevant sections of the above referenced approvals. The unit complies with all essential requirements of the Directives.

<i>Signed:</i>	<i>Name:</i>	<i>Position:</i>	<i>Manufacturer:</i>
	I L Sargent	Technical Director	Sargent Electrical Services Ltd Unit 39, Tokenspire Business Park Woodmansey, Beverley East Yorkshire, United Kingdom
<i>Date:</i>			

6.5 Electrical Connection

A) Battery Input Connector

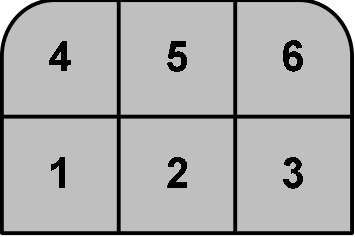
	Pin	Function	Fuse	Wire Colour
	4	Leisure battery input 1	1	BROWN / BLUE
	5	Vehicle battery input 1	2	BROWN / GREEN
	6	Battery common earth 1	-	WHITE / ORANGE
	1	Leisure battery input 2	1	BROWN / BLUE
	2	Vehicle battery input 2	2	BROWN / GREEN
	3	Battery common earth 2	-	WHITE / ORANGE

B) Signal Input Connector

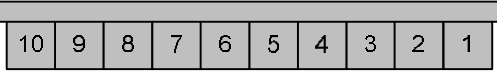
	Pin	Function	Wire Colour
	10	Not used	
	9	Not used	
	8	Fresh sensor 75% ($\frac{3}{4}$) full	ORANGE
	7	Fresh sensor 25% ($\frac{1}{4}$) full	WHITE
	6	Fresh sensor 100% full	GREEN
	5	Fresh sensor 50% ($\frac{1}{2}$) full	BLUE
	4	Waste sensor 50% ($\frac{1}{2}$) full	PURPLE / SLATE
	3	Waste sensor 100% full	PURPLE / RED
	2	Engine running signal	RED / YELLOW
	1	Earth	WHITE / ORANGE

C) Solar Panel Input Connector

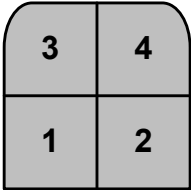
	Pin	Function	Wire Colour
	3	Positive (+) input	RED
	4	Not used	-
	1	Negative (-) input	BLACK
	2	Not used	-



EC328 Power Control System

D) 12v Output Connector

					Pin	Function	Fuse	Wire Colour
11	12	13	14	15	11	Ignitions	11	YELLOW / GREEN
6	7	8	9	10	12	Not Used	-	-
1	2	3	4	5	13	Radio / Entertainment	3	BROWN / YELLOW
					14	Internal Pump	4	GREEN / BLUE
					15	External Pump	5	GREEN / WHITE
					6	Rear Lights 1	8	PINK
					7	Rear Light 2	8	PINK
					8	Toilet Pump	12	PURPLE
					9	12v Sockets 1	9	YELLOW / WHITE
					10	12v Sockets 2	9	YELLOW / WHITE
					1	Front Lights 1	7	SLATE
					2	Front Lights 2	7	SLATE
					3	Auxiliary output	6	SLATE / RED
					4	Fans 1	10	BLACK / tracer
					5	Fans 2	10	BLACK / tracer

E) 230v Mains Input connector

			Pin	Function	Wire Colour
1	2	3	1	Live	BROWN
			2	Earth	GREEN / YELLOW
			3	Neutral	BLUE

F) 230v Mains output connector (2 off connectors wired identical)

			Pin	Function	MCB	Wire Colour
7	8	9	7	Live	3	BROWN
4	5	6	8	Earth	3	GREEN / YELLOW
1	2	3	9	Neutral	3	BLUE
			4	Live	2	BROWN
			5	Earth	2	GREEN / YELLOW
			6	Neutral	2	BLUE
			1	Live	1	BROWN
			2	Earth	1	GREEN / YELLOW
			3	Neutral	1	BLUE

While every effort has been made to ensure the accuracy and completeness of this document, no guarantee is given against errors or omissions. This document may be updated / improved over time therefore please check with your dealer / supplier for update information or visit www.sargentltd.co.uk